

FLENDER COUPLINGS
CATALOG **FLE 10.3**
EDITION 2023 EN



HIGHLY FLEXIBLE COUPLINGS
ELPEX-B, ELPEX-S AND ELPEX

HIGHLY FLEXIBLE COUPLINGS



Catalog FLE 10.3 Edition 2023 EN

Introduction

Torsionally Rigid Gear Couplings ZAPEX ZW

ZAPEX ZN

Torsionally Rigid All-Steel Couplings N-ARPEX, ARPEX

Flexible Couplings N-EUPEX

RUPEX

N-BIPEX

Highly Flexible Couplings

ELPEX-B

ELPEX-S

ELPEX

Fluid Couplings FLUDEX

Backlash-free Couplings SIPEX

BIPEX-S

Appendix

E

4

5

6

7

8

9

10

11

12

13

14

15

A

FLE 10 CATALOG GROUP



Product catalog FLE 10.1
FLEX-C10001-00-7600
Torsionally Rigid Couplings



Product catalog FLE 10.3
FLEX-C10003-00-7600
Highly Flexible Couplings



Product catalog FLE 10.2
FLEX-C10001-00-7600
Flexible Couplings



Product catalog FLE 10.4
FLEX-C10004-00-7600
Fluid Couplings

For further coupling catalogs, see page A/6

FLENDER COUPLINGS
CATALOG **FLE 10.5**
EDITION EN



HIGH PERFORMANCE COUPLINGS
ARPEX

flender.com

FLENDER

Product catalog FLE 10.5
FLEX-C10120-00-7600
High Performance Couplings

FLENDER-COUPLINGS
CATALOG **FLE 10.7**
EDITION EN



SAFETY COUPLINGS
ARPEX

flender.com

FLENDER

Product catalog FLE 10.7
FLEX-C10122-00-7600
Safety couplings

FLENDER COUPLINGS
CATALOG **FLE 10.6**
EDITION EN



BACKLASH-FREE COUPLINGS
SIPEX AND BIPEX-S

flender.com

FLENDER

Product catalog FLE 10.6
FLEX-C10121-00-7600
Backlash-free couplings

FLENDER CLAMPING ELEMENTS
CATALOG **FLE 10.8**
EDITION EN



CLAMPING ELEMENTS
FASTEX

flender.com

FLENDER

Product catalog FLE 10.8
FLEX-C10152-00
Clamping elements

INTRODUCTION

E

The mechanical drive train comprises individual units such as motor, gear unit and driven machine. The coupling connects these component assemblies.

As well as the transmission of rotary motion and torque, other requirements may be made of the coupling.

- Compensation for shaft misalignment with low restorative forces
- Control of characteristic angular vibration frequency and damping
- Interruption or limitation of torque
- Noise insulation, electrical insulation

Couplings are frequently chosen after the machines to be connected have already been selected. Thanks to a large number of different coupling assembly options, specified marginal conditions for clearance and connection geometry can be met from the standard range. The coupling also performs secondary functions, e.g. providing a brake disk or brake drum for operating or blocking brakes, devices to record speed or the attachment of sprockets or pulleys.

Couplings are divided into two main groups, couplings and clutches.

Clutches interrupt or limited the transmissible torque. The engaging and disengaging forces on externally operated clutches are introduced via a mechanically, electrically, hydraulically or pneumatically operating mechanism. Overload, centrifugal or freewheel clutches draw their engaging energy from the transmitted output.

Rigid couplings, designed as clamp, flanged or mechanism couplings, connect machines which must not undergo any shaft misalignment. Hydrodynamic couplings, often also called fluid or Föttinger couplings, are used as starting couplings in drives with high mass moments of inertia of the driven machine. In drive technology very often flexible, positive couplings, which may be designed to be torsionally rigid, torsionally flexible or highly flexible, are used.

Torsionally rigid couplings are designed to be rigid in a peripheral direction and flexible in radial and axial directions. The angle of rotation and torque are conducted through the coupling without a phase shift.

Torsionally flexible couplings have resilient elements usually manufactured from elastomer materials. Using an elastomer material with a suitable ShoreA hardness provides the most advantageous torsional stiffness and damping for the application. Shaft misalignment causes the resilient elements to deform.

Highly flexible couplings have large-volume (elastomer) resilient elements of low stiffness. The angle of rotation and torque are conducted through the coupling with a considerable phase shift.

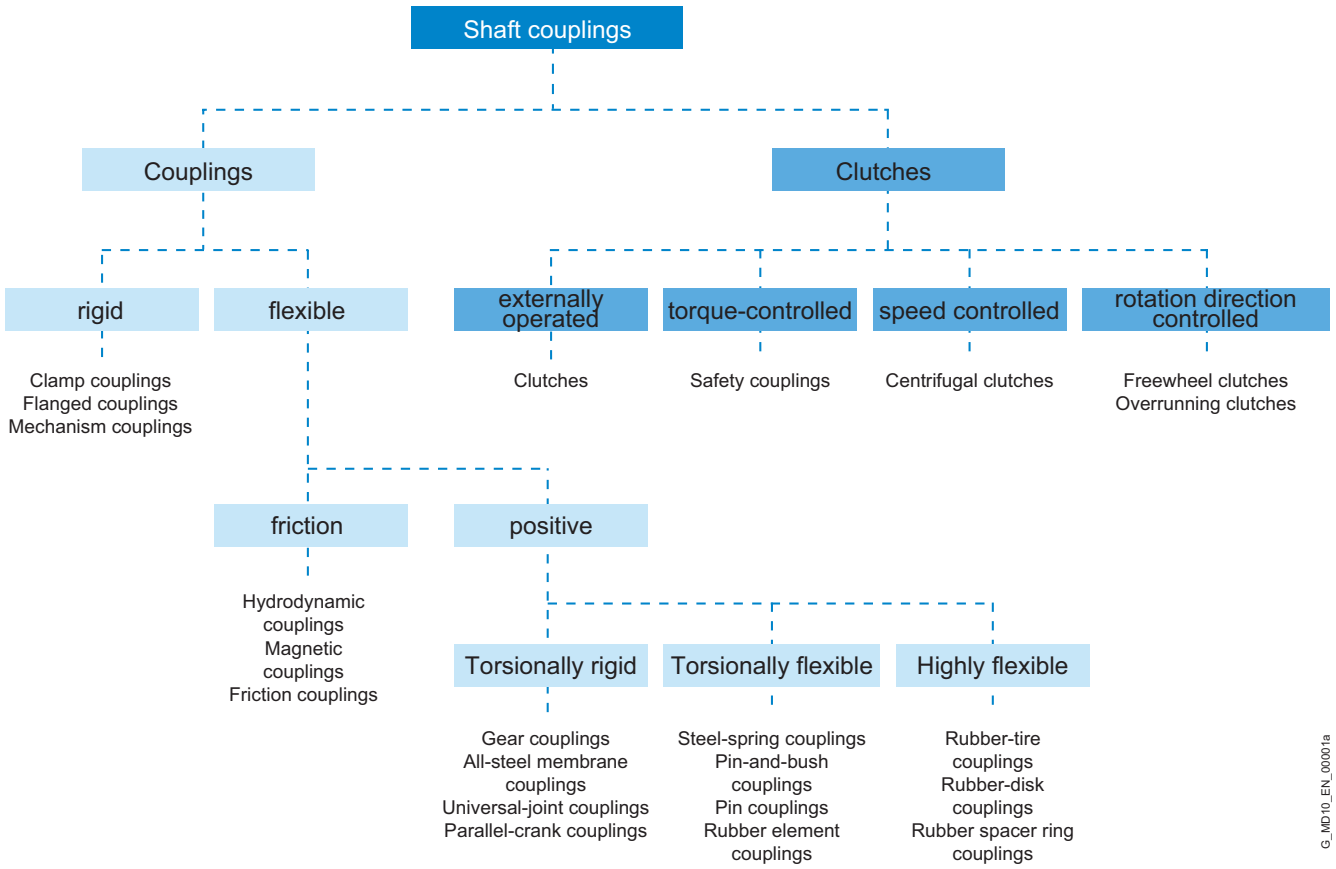

G_MD10_EN_00001a

OUR COUPLING GROUPS AT A GLANCE

E

N-EUPEX, RUPEX and N-BIPEX

Flexible Couplings

Flexible Flender couplings have a wide range of possible applications. A broad standard modular system as well as specially designed application-specific couplings are available.

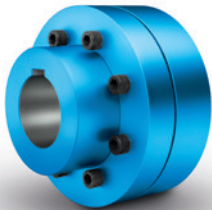

N-EUPEX
cam couplings
Rated torque:
19 Nm ... 85,000 Nm

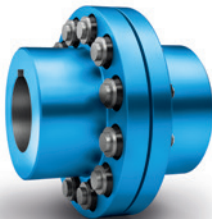

RUPEX
pin-and-bush couplings
Rated torque:
200 Nm ... 1,690,000 Nm



N-BIPEX
cam couplings
Rated torque:
12 Nm ... 4,650 Nm

ELPEX, ELPEX-B and ELPEX-S

Highly Flexible Couplings

ELPEX® couplings are free of circumferential back-lash. Their damping capacity and low torsional stiff-ness make them especially well-suited for coupling machines with strongly non-uniform torque characteristics or large shaft misalignment.



ELPEX
elastic ring couplings
Rated torque:
1,600 Nm ... 90,000 Nm



ELPEX-B
elastic tire couplings
Rated torque:
24 Nm ... 14,500 Nm



ELPEX-S
rubber disk couplings
Rated torque:
330 Nm ... 63,000 Nm

ZAPEX gear couplings and ARPEX all-steel couplings

Torsionally rigid couplings

For transmission of high torques, we offer both ARPEX all-steel couplings and ZAPEX gear couplings in a range of versions. Their purposes of application vary according to specific requirements with respect to shaft misalignment, temperature and torque.

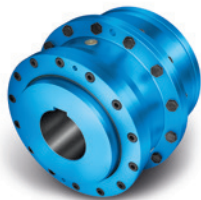

ZAPEX
gear couplings
Rated torque:
1,300 Nm ... 7,200,000 Nm



ARPEX
high Performance Couplings
Rated torque:
1,000 Nm ... 588,500 Nm



N-ARPEX and ARPEX
all-steel couplings
Rated torque:
92 Nm ... 2,000,000 Nm

BIPEX-S and SIPEX

Backlash-free couplings

The vibration-damping, electrically insulating plug-in BIPEX-S elastomer couplings and SIPEX metal bellows couplings with very high torsional stiffness deliver especially isogonal torque transmission.



BIPEX-S and SIPEX
Rated torque:
0.1 Nm ... 5,000 Nm

FLUDEX

Hydrodynamic couplings

The FLUDEX hydrodynamic fluid coupling works according to the Föttinger principle. It functions entirely free of wear.



FLUDEX
fluid Couplings
Power:
1.2 kW ... 2,500 kW

Application-specific couplings

Couplings for rail vehicles must meet high demands. Due to their high degree of standardization and wide variety, they can be used in the most diverse vehicle types.



Railway coupling
Rated torque:
1,000 Nm ... 9,500 Nm

Each wind turbine coupling is designed to optimally meet the requirements of the respective wind turbine. The coupling connects the fast-running gear shaft with the generator shaft and is available for wind turbines with a capacity of up to 12 MW.

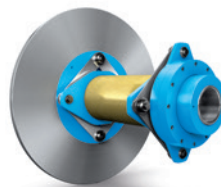

Wind turbine couplings
Rated torque:
10,000 Nm ... 60,000 Nm

TECHNICAL INFORMATION AND COUPLING SELECTION

Technical Information	E/10
Shaft misalignment	E/10
Balancing	E/11
Shaft-hub connections	E/13
Standards	E/14
Key to symbols	E/15
<hr/>	
Selection of the coupling series	E/16
Typical coupling solutions for different example applications	E/17
<hr/>	
Selection of the coupling size	E/18
Coupling load in continuous operation	E/18
Coupling load at maximum and overload conditions	E/19
Coupling load due to dynamic torque load	E/19
Checking the maximum speed	E/20
Checking permitted shaft misalignment	E/20
Checking bore diameter, mounting geometry and coupling design	E/20
Coupling behavior under overload conditions	E/20
Checking shaft-hub connection	E/20
Checking low temperature and chemically aggressive environment	E/20
<hr/>	
Features of the standard type	E/21
<hr/>	

TECHNICAL INFORMATION

E

Shaft misalignment

Shaft misalignment is the result of displacement during assembly and operation and, where machines constructed with two radial bearings each are rigidly coupled, will cause high loads being placed on the bearings. Elastic deformation of base frame, foundation and machine housing will lead to shaft misalignment which cannot be prevented, even by precise alignment.

Furthermore, because individual components of the drive train heat up differently during operation, heat expansion of the machine housings causes shaft misalignment. Poorly aligned drives are often the cause of seal, rolling bearing or coupling failure. Alignment should be carried out by specialist personnel in accordance with operating instructions.

Depending on the direction of the effective shaft misalignment a distinction is made between:

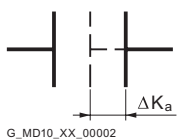

Axial misalignment

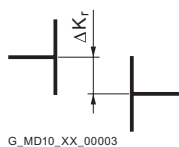

Radial misalignment

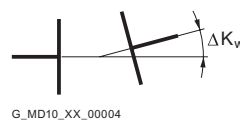

Angular misalignment

Couplings can be categorized into one of the following groups:

Single-joint couplings

Couplings with flexible elements mainly made of elastomer materials. Shaft misalignment results in deformation of the elastomer elements. The elastomer elements can absorb shaft misalignment as deformations in an axial, radial and angular direction. The degree of permissible misalignment depends on the coupling size, the speed and the type of elastomer element.

Single-joint couplings do not require an adapter and are therefore short versions.

Example:

In the case of a RUPLEX RWN 198 coupling with an outer diameter of 198 mm and a speed of 1500 rpm, the permitted radial misalignment is $\Delta K_r = 0.3$ mm.

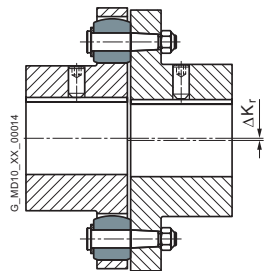

Two-joint couplings

Two-joint couplings are always designed with an adapter. The two joint levels are able to absorb axial and angular misalignment. Radial misalignment occurs via the gap between the two joint levels and the angular displacement of the joint levels. The permitted angular misalignment per joint level is frequently about 0.5°. The permitted shaft misalignment of the coupling can be adjusted via the length of the adapter. If there are more than two joint levels, it is not possible to define the position of the coupling parts relative to the axis of rotation. (The less frequently used parallel-crank couplings are an exception).

Example:

N-ARPEX ARN-6 NEN 217-6 with a shaft distance of 140 mm with a permitted radial misalignment of $\Delta K_r = 2.2$ mm [angle per joint level 1.0°].

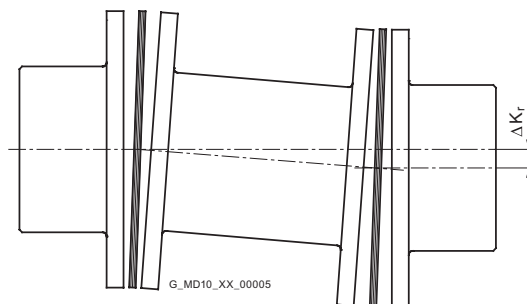

Balancing

Balance quality levels

The so-called quality level G to DIN ISO 21940 indicates a range of permitted residual imbalance from zero up to an upper limit. Applications can be grouped on the basis of similarity analysis. For many applications a coupling balance quality of G 16 is sufficient. On drives susceptible to vibration the balance quality should be G 6.3. Only in special cases is a better balance quality required.

Balancing standard in accordance with DIN ISO 21940-32

Besides the required balance quality, it is necessary to set standards which define how the mass of the parallel key is to be taken into consideration when balancing. In the past, motor rotors have frequently been balanced in accordance with the full parallel key standard. The "appropriate" balance condition of the coupling hub was described as "balancing with open keyway" or "balancing after keyseating". Today it is usual for the motor rotor, as well as the gear unit and driven machine shaft, to be balanced in accordance with the half parallel key standard.

Full parallel key standard

The parallel key is inserted in the shaft keyway, then balancing is carried out. The coupling hub must be balanced without parallel key after keyseating.

Marking of shaft and hub with "F" (for "full").

Half parallel key standard

The balancing standard normally applied today. Before balancing, a half parallel key is inserted in the shaft and another in the coupling hub. Alternatively, balancing can be carried out before cutting the keyway.

The balanced parts must be marked with an "H". This marking can be dispensed with if it is absolutely clear which parallel key standard has been applied.

No parallel key standard

Balancing of shaft and coupling hub after keyseating, but without parallel key. Not used in practice. Marking of shaft and hub with "N" (for "no").
The length of the parallel key is determined by the shaft keyway. Coupling hubs may be designed considerably shorter than the shaft.

To prevent imbalance forces caused by projecting parallel key factors when balancing in accordance with the half parallel key standard in the case of applications with high balancing quality requirements, grooved spacer rings can be fitted or stepped parallel keys used.

Flender Balancing Standard

The balancing quality level, together with the operating speed, results in the maximum permissible eccentricity of the center of gravity of the coupling or the coupling subassembly. In the Flender article number the balancing quality can be preset with the help of the order code. Additionally, also the balance quality level to DIN ISO 21940 can be preset together with the operating speed belonging to it, which then be taken as priority.

$$e_{perm} = 9550 \cdot \frac{G}{n}$$

$$e_{coupl} \leq e_{perm}$$

Permitted eccentricity of center of gravity e_{perm} in μm
 Eccentricity of center of gravity of coupling e_{coupl} in μm
 Balancing quality level G in mm/s
 Coupling speed n in rpm

Eccentricity of center of gravity of coupling e_{coupl}	Flender balancing quality	Order code
maximum 100 μm	standard balancing	without specification
maximum 40 μm	fine balancing	W02
maximum 16 μm	micro-balancing	W03
better than 16 μm	special balancing	on request

TECHNICAL INFORMATION

E

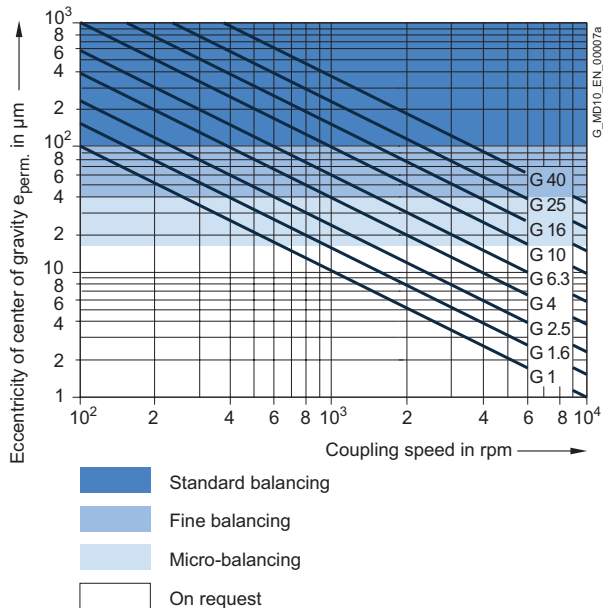

Example:
Coupling speed = 1450 rpm
required balancing quality level G 6.3

$$e_{perm} = 9550 \cdot \frac{G}{n} = 9550 \cdot \frac{6.3}{1450} \mu\text{m}$$

Thus, the required eccentricity of center of gravity is 41.5 µm. The fine balancing with a maximum eccentricity of center of gravity of 40 mm fulfills this requirement; therefore, the order code W02 has to be specified when ordering.

For many applications the following balancing quality recommendation applies:

Coupling	standard balancing $v = DA \cdot n/19100$	fine balancing
short version with $LG \leq 3 \times DA$	$v < 30 \text{ m/s}$	$v > 30 \text{ m/s}$
long version with $LG > 3 \times DA$	$v \leq 15 \text{ m/s}$	$v > 15 \text{ m/s}$

Peripheral speed	v	in mm/s
Coupling outer diameter	DA	in mm
Coupling speed	n	in rpm
Coupling length	LG	in mm

The following standards on balancing must be observed:

- couplings are balanced in subassemblies.
- hub parts without finished bore are unbalanced.
- the number of balancing levels (one- or two-level balancing) is specified by Flender.
- without special specification balancing is done in accordance with the half-parallel-key standard. Balancing in accordance with the full-parallel-key standard must be specified in the order number.
- For FLUDEX couplings special balancing standards specified in Section 13 apply.
- ARPEX couplings in standard balancing quality are unbalanced. Thanks to steel components machined all over and precisely guided adapters the balancing quality of standard balancing is nearly always adhered to.

Shaft-hub connections

The bore and the shaft-hub connection of the coupling are determined by the design of the machine shaft. In the case of IEC standard motors, the shaft diameters and parallel key connections are specified in accordance with DIN EN 50347. For diesel motors, the flywheel connections are frequently specified in accordance with SAE J620d or DIN 6288. Besides the very widely used connection of shaft and hub with parallel keys to DIN 6885 and cylindrically bored hubs, couplings with Taper clamping bushes, clamping sets, shrink-fit connections and splines to DIN 5480 are common.

The form stability of the shaft/hub connection can only be demonstrated when shaft dimensions and details of the connection are available. The coupling torques specified in the tables of power ratings of the coupling series do not apply to the shaft-hub connection unrestrictedly.

In the case of the shaft-hub connection with parallel key, the coupling hub must be axially secured, e.g. with a set screw or end washer. The parallel key must be secured against axial displacement in the machine shaft.

All Flender couplings with a finished bore and parallel keyway are designed with a set screw. Exceptions are some couplings of the FLUDEX series, in which end washers are used. During assembly, Taper clamping bushes are frictionally connected to the machine shaft.

TECHNICAL INFORMATION

E

Standards

Machines

2006/42/EG	EC Machinery Directive
2014/34/EU	ATEX Directive – Manufacturer
1999/92/EG	ATEX Directive – Operator – and ATEX Guideline to Directive 1999/92/EC
DIN EN 80079-36	Non-electrical equipment for use in potentially explosive atmospheres
DIN EN 1127	Explosive atmospheres, explosion prevention and protection
DIN EN 50347	General-purpose three-phase induction motors having standard dimensions and outputs

Couplings

DIN 740	Flexible shaft couplings Part 1 and Part 2
VDI Guideline 2240	Shaft couplings - Systematic subdivision according to their properties VDI Technical Group Engineering Design 1971
API 610	Centrifugal Pumps for Petroleum, Chemical and Gas Industry Services
API 671	Special Purpose Couplings for Petroleum, Chemical and Gas Industry Services
ISO 10441	Petroleum, petrochemical and natural gas industries – Flexible couplings for mechanical power transmission-special-purpose applications
ISO 13709	Centrifugal pumps for petroleum, petrochemical and natural gas industries

Balancing

DIN ISO 21940	Requirements for the balancing quality of rigid rotors
DIN ISO 21940-32	Mechanical vibrations; standard governing the type of parallel key during balancing of shafts and composite parts

Shaft-hub connections

DIN 6885	Driver connections without taper action – parallel keys – keyways
SAE J620d	Flywheels for industrial engines ...
DIN 6288	Reciprocating internal combustion engines Dimensions and requirements for flywheels and flexible couplings
ASME B17.1	Keys and keyseats
DIN EN 50347	General-purpose three-phase induction motors with standard dimensions and output data
BS 46-1:1958	Keys and keyways and taper pins Specification

Key to symbols

Name	Symbols	Unit	Explanation
Torsional stiffness, dynamic	C_{Tdyn}	Nm/rad	For calculating torsional vibration
Excitation frequency	f_{err}	Hz	Excitation frequency of motor or driven machine
Moment of inertia	J	kgm ²	Moment of inertia of coupling sides 1 and 2
Axial misalignment	ΔK_a	mm	Axial misalignment of the coupling halves
Radial misalignment	ΔK_r	mm	Radial misalignment of the coupling halves
Angular misalignment	ΔK_w	°	Angular misalignment of the coupling halves
Service factor	FB		Factor expressing the real coupling load as a ratio of the nominal coupling load
Frequency factor	FF		Factor expressing the frequency dependence of the fatigue torque load
Temperature factor	FT		Factor taking into account the reduction in strength of flexible rubber materials at a higher temperature
Weight	m	kg	Weight of the coupling
Rated speed	n_N	rpm	Coupling speed
Maximum coupling speed	n_{Kmax}	rpm	Maximum permissible coupling speed
Rated power	P_N	kW	Rated output on the coupling, usually the output of the driven machine
Rated torque	T_N	Nm	Rated torque as nominal load on the coupling
Fatigue torque	T_W	Nm	Amplitude of the dynamic coupling load
Maximum torque	T_{max}	Nm	More frequently occurring maximum load, e.g. during starting
Overload torque	T_{OL}	Nm	Very infrequently occurring maximum load, e.g. during short circuit or blocking conditions
Rated coupling torque	T_{KN}	Nm	Torque which can be transmitted as static torque by the coupling over the period of use.
Maximum coupling torque	T_{Kmax}	Nm	Torque which can be frequently transmitted (up to 25 times an hour) as maximum torque by the coupling.
Coupling overload torque	T_{KOL}	Nm	Torque which can very infrequently be transmitted as maximum torque by the coupling.
Fatigue coupling torque	T_{KW}	Nm	Torque amplitude which can be transmitted by the coupling as dynamic torque at a frequency of 10 Hz over the period of use.
Resonance factor	V_R		Factor specifying the torque increase at resonance
Temperature	T_a	°C	Ambient temperature of the coupling in operation
Damping coefficient	Ψ	psi	Damping parameter

SELECTION OF THE COUPLING SERIES

E

The coupling series is frequently determined by the driven machine and the design of the drive train. Common selection criteria are listed below and assigned to coupling properties, which are used to select the coupling series. Additionally, the price of the coupling and availability are important criteria for determining the coupling series to be used.

The **FLUDEX series** operates positively and transmits the torque with the aid of a flowing oil or water filling.

FLUDEX couplings are used to reduce starting and/or overload torques. During starting, the motor may, for example, run up within a very short time; because of the FLUDEX coupling, the drive train with the driven machine may accelerate after a delay and without increased torque load.

The FLUDEX coupling cannot compensate for shaft misalignment and is therefore designed in combination with a displacement coupling, a cardan shaft or a belt drive. The displacement coupling may be selected in accordance with the criteria described below.

Selection criteria	Torque range	Speed range	Torsional stiffness		Highly flexible	Operating temperature range
	Rated coupling torque T_{KN}	Peripheral speed $v_{max} = DA \cdot n_{max}/19100$	torsionally rigid	torsionally flexible		
ZAPEX	850 ... 7200000 Nm	60 m/s	■	-	-	-20 ... +80 °C
N-ARPEX	350 ... 2000000 Nm	110 m/s	■	-	-	-50 ... +280 °C
ARPEX	92 ... 2000000 Nm	100 m/s	■	-	-	-40 ... +280 °C
N-EUPEX	12 ... 93500 Nm	36 m/s	-	■	-	-50 ... +100 °C
N-EUPEX DS	19 ... 21200 Nm	36 m/s	-	■	-	-30 ... +80 °C
RUPEX	200 ... 1300000 Nm	60 m/s	-	■	-	-50 ... +100 °C
N-BIPEX	12 ... 4650 Nm	45 m/s	-	■	-	-50 ... +100 °C
ELPEX-B	24 ... 14500 Nm	35 m/s	-	-	■	-50 ... +70 °C
ELPEX-S	330 ... 63000 Nm	66 m/s	-	-	■	-40 ... +120 °C
ELPEX	1600 ... 900000 Nm	60 m/s	-	-	■	-40 ... +80 °C

Typical coupling solutions for different example applications

The specified application factors are recommendations; regulations, rules and practical experience take priority as assessment criteria.

No application factor need be taken into account with FLUDEX couplings.

In the case of highly flexible couplings of the ELPEX, ELPEX-S and ELPEX-B series, deviating application factors are stated in the product descriptions.

FLUDEX couplings are mostly mounted on the high-speed gear shaft.

Example applications	Application factor FB
Electric motor without gear unit	
Centrifugal pumps	1.0
Piston pumps	1.5
Vacuum pumps	1.5
Fans with T_N less than 75 Nm	1.5
Fans with T_N from 75 to 750 Nm	1.75
Fans with T_N larger than 750 Nm	1.75
Blowers	1.5
Frequency converters / generators	1.25
Reciprocating compressors	1.75
Screw-type compressors	1.5
Internal-combustion engine without gear unit	
Generators	1.75
Pumps	1.5
Fans	1.75
Hydraulic pumps, excavators, construction machines	1.5
Compressors / screw-type compressors	1.5
Agricultural machinery	1.75
Other	
Turbine gear units	1.5
Hydraulic motor - gear unit	1.25
Electric motor with gear unit	
Chemical industry	
Extruders	1.5
Pumps - centrifugal pumps	1.0
Pumps - piston pumps	1.75
Pumps - plunger pumps	1.5
Reciprocating compressors	1.75
Calenders	1.5
Kneaders	1.75
Cooling drums	1.25
Mixers	1.25
Stirrers	1.25
Toasters	1.25
Drying drums	1.25
Centrifuges	1.25
Crushers	1.5
Power generation and conversion	
Compressed air, reciprocating compressors	1.75

Example applications	Application factor FB
Compressed air, screw-type compressors	1.25
Air - Blowers	1.5
Air - Cooling tower fans	1.5
Air - Turbine blowers	1.5
Generators, converters	1.25
Welding generators	1.25
Metal production, iron and steel works	
Plate tilters	1.5
Ingot pushers	1.75
Slabbing mill	1.75
Coiling machines	1.5
Roller straightening machines	1.5
Roller tables	1.75
Shears	1.75
Rollers	1.75
Metal working machines	
Plate bending machines	1.5
Plate straightening machines	1.5
Hammers	1.75
Planing machines	1.75
Presses, forging presses	1.75
Shears	1.5
Grinding machines	1.25
Punches	1.5
Machine tools: Main drives	1.5
Machine tools: Auxiliary drives	1.25
Food industry	
Filling machines	1.25
Kneading machines	1.5
Mashers	1.5
Sugar cane production	1.5
Production machines	
Construction machines, hydraulic pumps	1.25
Construction machines, traversing gears	1.5
Construction machines, suction pumps	1.5
Construction machines, concrete mixers	1.5
Printing machines	1.25
Woodworking - barking drums	1.5
Woodworking - planing machines	1.5

Example applications	Application factor FB
Woodworking - reciprocating saws	1.5
Grinding machines	1.5
Textile machines - winders	1.5
Textile machines - printing machines	1.5
Textile machines - tanning vats	1.5
Textile machines - shredders	1.5
Textile machines - looms	1.5
Packaging machines	1.5
Brick molding machines	1.75
Transport and logistics	
Passenger transport - elevators	1.5
Passenger transport - escalators	1.5
Conveyor systems - bucket elevators	1.5
Conveyor systems - hauling winches	1.5
Conveyor systems - belt conveyors	1.5
Conveyor systems - endless-chain conveyors	1.5
Conveyor systems - circular conveyors	1.5
Conveyor systems - screw conveyors	1.5
Conveyor systems - inclined hoists	1.5
Crane traversing gear	1.5
Hoisting gear	1.5
Crane lifting gear	2.0
Crane traveling gear	1.5
Crane slewing gear	1.5
Crane fly jib hoists	1.5
Cable railways	1.5
Drag lifts	1.5
Winches	1.5
Cellulose and paper	
Paper-making machines, all	1.5
Pulper drives	1.5
Cement industry	
Crushers	1.75
Rotary furnaces	1.5
Hammer mills	1.75
Ball mills	1.75
Pug mills	1.75
Mixers	1.5
Pipe mills	1.5
Beater mills	1.75
Separators	1.5
Roller presses	1.75

SELECTION OF THE COUPLING SIZE

E

The torque load of the coupling must be determined from the output of the driven machine and the coupling speed.

Rated coupling load $T_N = 9550 \times P_N / n_N$
 (T_N in Nm; P_N in kW; n_N in rpm)

The rated coupling load obtained in this way must be multiplied by factors and compared with the rated coupling torque. An ideal but expensive method is to measure the torque characteristic on the coupling. For this, Flender offers special adapters fitted with torque measuring devices.

The rated coupling torque T_{KN} is the torque which can be transmitted by the coupling over an appropriate period of use if the load is applied to the coupling purely statically at room temperature.

Application factors are to express the deviation of the real coupling load from the "ideal" load condition.

Coupling load in continuous operation

The operating principles of the driving and driven machines are divided into categories and the application factor FB derived from these in accordance with DIN 3990-1.

Application factor for N-EUPEX, N-EUPEX-DS, RUPEX, N-BIPEX, ELPEX-B, N-ARPEX, ARPEX, ZAPEX and FLUDEX

Application factor FB				
Torque characteristic of the driving machine	Torque characteristic of the driven machine			
	uniform	uniform with moderate shock loads	non uniform	very rough
uniform	1.0	1.25	1.5	1.75
uniform with moderate shock loads	1.25	1.5	1.75	2.0
non uniform	1.5	1.75	2.0	2.5

Examples of torque characteristic of driving machines:

- uniform: Electric motors with soft starting, steam turbines
- uniform with moderate shock loads: Electric motors without soft starting, hydraulic motors, gas and water turbines
- non uniform: Internal-combustion engines

Examples of torque characteristic in driven machines:

- uniform: Generators, centrifugal pumps for light fluids
- uniform with moderate shock loads: Centrifugal pumps for viscous fluids, elevators, machine tool drives, centrifuges, extruders, blowers, crane drives
- non uniform: Excavators, kneaders, conveyor systems, presses, mills
- very rough: Crushers, excavators, shredders, iron/smelting machinery

Temperature factor FT												
Coupling	Elastomer material	Low temperature °C	Temperature T_a on the coupling									
			under -30 °C	-30 °C up to 50 °C	up to 60 °C	up to 70 °C	up to 80 °C	up to 90 °C	up to 100 °C	up to 110 °C	up to 120 °C	
N-EUPEX	NBR	-30	-	1.0	1.0	1.0	1.0	1.0	-	-	-	-
N-EUPEX	NR	-50	1.1 ¹⁾	1.0	-	-	-	-	-	-	-	-
N-EUPEX	HNBR	-10	-	1.0	1.0	1.0	1.0	1.0	1.25	1.25	-	-
N-EUPEX	TPU	-50	1.0	1.0	1.05	1.10	1.15	-	-	-	-	-
N-EUPEX DS	NBR	-30	-	1.0	1.0	1.0	1.0	-	-	-	-	-
RUPEX	NBR	-30	-	1.0	1.0	1.0	1.0	-	-	-	-	-
RUPEX	NR	-50	1.1	1.0	-	-	-	-	-	-	-	-
RUPEX	HNBR	-10	-	1.0	1.0	1.0	1.0	1.0	1.25	1.25	-	-
N-BIPEX	TPU	-50	1.0	1.0	1.0	1.0	1.0	1.0	1.0	1.3	1.5	-
ELPEX	NR	-40	1.1	1.0	1.25	1.40	1.60	-	-	-	-	-
ELPEX-B	NR	-50	1.1	1.0	-	-	-	-	-	-	-	-
ELPEX-B	CR	-15	-	1.0	1.0	1.0	-	-	-	-	-	-
ELPEX-S SN, NN, WN	NR	-40	1.1	1.0	1.25	1.40	1.60	-	-	-	-	-
ELPEX-S NX	VMQ	-40	1.1	1.0	1.0	1.0	1.0	1.1	1.25	1.4	1.6	-

- NR = natural rubber, natural-synthetic rubber mixture
- NBR = nitril-butadiene-rubber (Perbunan)
- HNBR = hydrated acrylonitrile butadiene rubber
- CR = chloroprene rubber (FRAS fire-resistant and anti-static)
- VMQ = silicone
- TPU = polyurethane

¹⁾ The N-EUPEX coupling is not suitable for shock loads when used at low temperatures.

Coupling size $T_{KN} \geq T_N \cdot FB \cdot FT$

In the case of ARPEX and ZAPEX coupling types, no temperature factor (FT = 1.0) need be taken into account.

Coupling load at maximum and overload conditions

The maximum torque is the highest load acting on the coupling in normal operation. Maximum torques at a frequency of up to 25 times an hour are permitted and must be lower than the maximum coupling torque. Examples of maximum torque conditions are: Starting operations, stopping operations or usual operating conditions with maximum load.

$T_{Kmax} \geq T_{Max} \cdot FT$

Overload torques are maximum loads which occur only in combination with special, infrequent operating conditions. Examples of overload torque conditions are: Motor short circuit, emergency stop or blocking because of component breakage. Overload torques at a frequency of once a month are permitted and must be lower than the maximum overload torque of the coupling. The overload condition may last only a short while, i.e. fractions of a second.

$T_{KOL} \geq T_{OL} \cdot FT$

Coupling load due to dynamic torque load

Applying the frequency factor FF, the dynamic torque load must be lower than the coupling fatigue torque.

Dynamic torque load

$T_{KW} \geq T_W \cdot FF$

Frequency of the dynamic torque load $f_{err} \leq 10$ Hz frequency factor FF = 1.0

Frequency of the dynamic torque load $f_{err} > 10$ Hz frequency factor FF = $\sqrt{f_{err}/10}$ Hz

For the ZAPEX and ARPEX series, the frequency factor is always FF = 1.0.

SELECTION OF THE COUPLING SIZE

E

Checking the maximum speed

For all load situations $n_{Kmax} \geq n_{max}$

Checking permitted shaft misalignment

For all load situations, the actual shaft misalignment must be less than the permitted shaft misalignment.

Checking bore diameter, mounting geometry and coupling design

The check must be made on the basis of the dimension tables. The maximum bore diameter applies to parallel keyways to DIN 6885. For other keyway geometries, the maximum bore diameter can be reduced.

On request, couplings with adapted geometry can be provided.

Coupling behavior under overload conditions

The ZAPEX, N-ARPEX, ARPEX, N-EUPEX, RUPEX and N-BIPEX coupling series can withstand overloads until the breakage of metal parts. These coupling series are designated as fail-safe.

The N-EUPEX DS, ELPEX-B, ELPEX-S and ELPEX coupling series throw overload. The elastomer element of these couplings is irreparably damaged without damage to metal parts when subjected to excessive overload.

These coupling series are designated as non-fail-safe. These types that fail can be fitted with a so-called fail-safe device. This additional component enables emergency operation, even after the rubber element of the coupling has been irreparably damaged.

Checking shaft-hub connection

The torques specified in the tables of power ratings data of the coupling series do not necessarily apply to the shaft-hub connection. Depending on the shaft-hub connection, proof of form stability is required. Flender recommends obtaining proof of form strength by using calculation methods in accordance with the current state of the art.

Fitting recommendations for the shaft-hub connection are given in the **Appendix**.

The coupling hub is frequently fitted flush with the shaft end face. If the shaft projects, the risk of collision with other coupling parts must be checked. If the shaft is set back, in addition to the load-bearing capacity of the shaft-hub connection, the correct positioning of the hub must be ensured as well. If the bearing hub length is insufficient, restorative forces may cause tilting movements and so wear to and impairment of the axial retention. Also, the position of the set screw to be positioned on sufficient shaft or parallel key material must be noted.

Shaft-hub connection	Suggestion for calculation method
Keyway connection to DIN 6885-1	DIN 6892
Shrink fit	DIN 7190
Spline to DIN 5480	
Bolted flange connection	VDI 2230
Flange connection with close-fitting bolts	

Checking low temperature and chemically aggressive environment

The minimum permitted coupling temperature is specified in the Temperature factor FT table. In the case of chemically aggressive environments, please consult the manufacturer.

FEATURES OF THE STANDARD TYPE



Couplings	Features of the standard type
All coupling series except ARPEX clamping hubs and FLUDEX with keyway to ASME B17.1	Bore tolerance H7
N-ARPEX and ARPEX clamping hubs	Bore tolerance G6 (suitable for shaft tolerance h6)
FLUDEX couplings with keyway to ASME B17.1	Hollow shafts: bore tolerance K7 other parts: bore tolerance M7
All coupling series with bore diameter - imperial	Parallel keyway to ASME B17.1
Bore diameter metric in the case of ZAPEX, N-ARPEX and ARPEX coupling series as well as coupling hubs with applied brake disks or brake drums of the N-EUPEX and RUPEX series	Parallel keyway to DIN 6885-1 keyway width P9
Bore diameter metric in the case of the N-EUPEX, RUPEX, N-BIPEX, ELPEX-S, ELPEX-B, ELPEX, FLUDEX coupling series	Parallel keyway to DIN 6885-1 keyway width JS9
All coupling series except FLUDEX	Axial locking by means of set screw
FLUDEX coupling series	Axial lock by means of set screw or end washer
All coupling series	Balancing in accordance with half parallel key standard
ZAPEX, N-ARPEX, ARPEX, N-EUPEX, RUPEX, N-BIPEX, ELPEX-S, ELPEX-B and ELPEX coupling series	Balancing quality G16
FLUDEX coupling series	Balancing quality G6.3
SIPEX and BIPEX-S coupling series	Balancing quality G6.3 for 3600 rpm
All series	Unpainted
All series	Preservation with cleaning emulsion
FLUDEX couplings	Fuse 140 °C

Configurator

The article number can be obtained with the help of the Configurator. The coupling can be selected in a product configurator and specified using selection menus.

The coupling can be selected via "Technical selection" (technical selection) or via "Direct selection" (via article-no.).

The Configurator is available under flender.com.

HIGHLY FLEXIBLE COUPLINGS ELPEX-B SERIES



General	10/3
Benefits	10/3
Application	10/3
Design and configurations	10/4
Technical specifications	10/6
<hr/>	
Type EBWN	10/7
<hr/>	
Type EBWT	10/8
<hr/>	
Type EBWZ	10/10
<hr/>	
Spare and wear parts	10/12
<hr/>	



ELPEX-B
FLENDER

GENERAL



ELPEX-B couplings are highly flexible and free of torsional backlash. Because of their low torsional stiffness and damping capacity, ELPEX-B couplings are especially suitable for coupling machines with a highly non uniform torque pattern. ELPEX-B couplings are also suitable for connecting machines with high shaft misalignment.

Standard ELPEX-B coupling types are designed as shaft-shaft connections. Application-related types can be implemented on request.

Benefits

The ELPEX-B coupling is suitable for horizontal and vertical mounting positions or mounting positions at any required angle.

The elastic tire is slit at the circumference and can be changed without having to move the coupled machines.

The elastic tire is fitted without backlash and gives the coupling linear torsional stiffness, thus the torsional rigidity remains constant as the load on the coupling increases.

The ELPEX-B coupling is especially suitable for reversing operation or operation with changing directions of load. The coupling parts can be arranged as required on the shafts to be connected.

If the elastic tire is irreparably damaged or worn, the metal parts can rotate freely against one another because they are not in contact with one another.

Application

The ELPEX-B coupling is available as a catalog standard in 15 sizes with a rated torque of between 24 Nm and 14500 Nm. The coupling can be fitted with elastic tires made of natural rubber for ambient temperatures of -50 °C to +50 °C and with elastic tires made of chloroprene rubber for -15 °C to +70 °C.

The chloroprene rubber tire is marked FRAS, "Fire-resistant and Antistatic".

GENERAL

Design and configurations

The ELPEX-B coupling's transmission characteristic is determined essentially by the elastic tire. The elastic tire is manufactured from a natural rubber or a chloroprene rubber mixture with a multiply fabric insert. The elastic tire is fastened to the hubs with bolts and two clamping rings.

In type EBWT, the shaft-hub connection is achieved with Taper clamping bushes, in type EBWN with finish-drilled hubs and parallel keys. The type EBWZ connects the machine shafts additionally via a detachable adapter.

Metal part materials

- EN-GJL-250 grey cast iron or steel.

Elastic tire material

Material	Hardness	Marking	Ambient temperature
Natural rubber	70 ShoreA	48	-50 ... +50 °C
Chloroprene rubber	70 ShoreA	068 FRAS	-15 ... +70 °C

10

ELPEX-B coupling types

Type	Description
EBWN	Coupling as a shaft-shaft connection with drilled and grooved hubs
EBWT	Coupling as a shaft-shaft connection with Taper clamping bushes
EBWZ	Coupling as shaft-shaft connection with detachable adapter

Further application-specific coupling types are available; dimension sheets for and information on these are available on request.

The coupling types set up for shaft-hub connections with Taper clamping bushes are designated as follows:

- Variant A: Coupling with part 3 – part 3
- Variant B: Coupling with part 4 – part 4
- Variant AB: Coupling with part 3 – part 4

In the case of part 3, the Taper clamping bush is screwed in from the shaft end face side. The coupling half must be fitted before the machines to be connected are pushed together.

In the case of part 4, the Taper clamping bush is screwed in from the machine-housing side. If there is insufficient room, the Taper clamping bushes cannot be fitted from this side. Besides fitting space for the Taper clamping bush bolts, space for the fitting tool (offset screwdriver) must be taken into account.

In the case of coupling type EBWT, part 3 and part 4 can be combined as required. Furthermore, the variant with a Taper clamping bush can be combined with the finish-drilled hub.

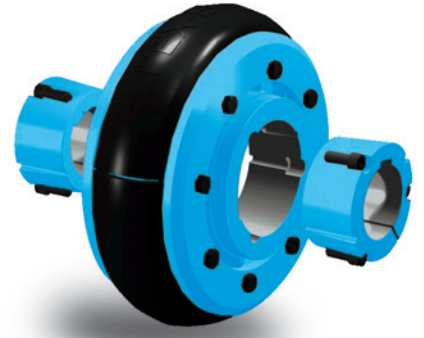

Unfitted coupling

Fitted coupling
(shown without connecting shafts)

Fitted elastic tire

The elastic tire can simply be slipped over the hub parts. The elastic tire is held firmly in place by fitting the clamping ring. The connection transmits the torque by frictional engagement.

GENERAL

Technical specifications

Power ratings									
Size	Rated torque	Maximum torque	Overload torque	Fatigue torque	Maximum speed	Dynamic torsional stiffness	Permitted shaft misalignment at $n = 1500$ rpm ¹⁾		
	T_{KN} Nm	T_{Kmax} Nm	T_{KOL} Nm	T_{KW} Nm	n_{Kmax} rpm	C_{Tdyn} Nm/rad	Axial ΔK_a mm	Radial ΔK_r mm	Angle ΔK_w Degree
105	24	48	72	7	4500	285	1.3	1.1	4
135	66	132	200	20	4500	745	1.7	1.3	4
165	125	250	375	38	4000	1500	2	1.6	4
190	250	500	750	75	3600	2350	2.3	1.9	4
210	380	760	1140	114	3100	3600	2.6	2.1	4
235	500	1000	1500	150	3000	5200	3	2.4	4
255	680	1360	2040	204	2600	7200	3.3	2.6	4
280	880	1760	2640	264	2300	10000	3.7	2.9	4
315	1350	2700	4050	405	2050	17000	4	3.2	4
360	2350	4700	7050	705	1800	28000	4.6	3.7	4
400	3800	7600	11400	1140	1600	44500	5.3	4.2	4
470	6300	12600	18900	1890	1500	78500	6	4.8	4
510	9300	18600	27900	2790	1300	110000	6.6	5.3	4
560	11500	23000	34500	3450	1100	160000	7.3	5.8	4
630	14500	29000	43500	4350	1000	200000	8.2	6.6	4

Torsional stiffness and damping

The damping coefficient is $\Psi = 0.9$

The technical data for the elastic tires made of natural rubber and chloroprene rubber are virtually identical.

Torsional stiffness depends on the ambient temperature and the frequency and amplitude of the torsional vibration excitation. More precise torsional stiffness and damping parameters on request.

With flexible couplings the manufacturing process of the rubber elements and their aging primarily influence the stiffness value C_{Tdyn} . For this reason calculation must be made with a tolerance for the dynamic stiffness of $\pm 20\%$. The specified damping coefficient Ψ is a minimum value with the result that the damping performance of the coupling corresponds at least to the specified value.

Permitted shaft misalignment

The permitted shaft misalignment depends on the operating speed. As the speed increases, lower shaft misalignment values are permitted. The correction factors for different speeds are specified in the following table. The maximum speed for the respective coupling size must be noted.

$$\Delta K_{perm} = \Delta K_{1500} \cdot FKV$$

	Speed in rpm			
	500	1000	1500	3000
Correction factor FKV	1.2	1.1	1.0	0.7

The restorative force (including in the axial direction) depends on speed, system torque and shaft misalignment. Restorative forces on request.

¹⁾ The maximum speed for the respective type must be noted. For additional information on the allowable shaft misalignment, please refer to the operating instructions.

TYPE EBWN

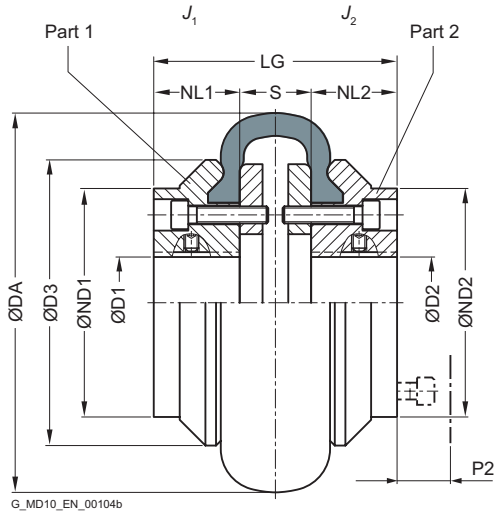

Sizes 105 ... 165

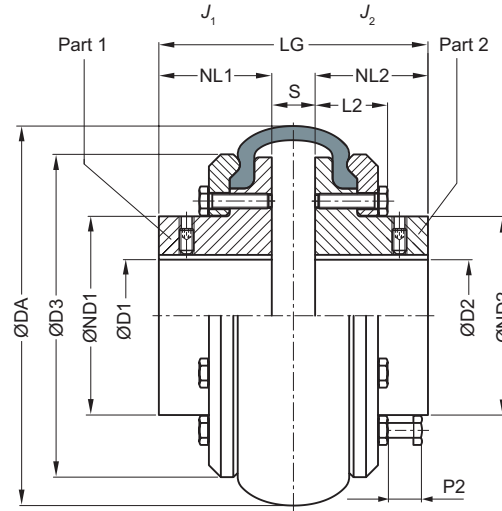

Sizes 190 ... 630

Size	Rated torque T_{KN} Nm	Dimensions in mm										Mass moment of inertia J_1/J_2 kgm ²	Article no. ¹⁾	Weight m kg
		D1, D2 Keyway DIN 6885-1 min. max.		DA	ND1/ ND2	NL1/ NL2	D3	L2	S	P2	LG			
105	24	-	30	104	70	30	82	-	22	35	82	0.0011	2LC0210-0AA	2.2
135	66	-	38	134	80	40	100	-	25	35	105	0.0025	2LC0210-1AA	3.6
165	125	-	45	165	70	50	125	-	33	35	133	0.0056	2LC0210-2AA	5.4
190	250	-	50	187	80	55	145	36	23	35	133	0.0095	2LC0210-3AA	6.9
210	380	-	60	211	98	65	168	40	25	35	155	0.02	2LC0210-4AA	11
235	500	-	70	235	111	70	188	45	27	35	167	0.023	2LC0210-5AA	14.8
255	680	-	80	254	130	75	216	44	27	35	177	0.06	2LC0210-6AA	20
280	880	-	90	280	145	80	233	45	25	35	185	0.083	2LC0210-7AA	24.5
315	1350	-	95	314	155	90	264	50	29	35	209	0.129	2LC0210-8AA	35
360	2350	-	125	359	200	100	311	50	32	35	232	0.32	2LC0211-0AA	54
400	3800	-	135	402	216	125	345	59	30	35	280	0.55	2LC0211-1AA	78
470	6300	-	160	470	260	140	398	67	46	35	326	1.12	2LC0211-2AA	120
510	9300	-	140	508	250	150	429	73	48	35	348	1.6	2LC0211-3AA	146
		140	290		1.7							154		
560	11500	-	140	562	250	165	474	82	55	35	385	2.5	2LC0211-4AA	200
		140	300		2.7							206		
630	14500	80	140	629	250	195	532	82	59	35	449	4.1	2LC0211-5AA	258
		140	180		300							4.4		265

Configurable variants¹⁾

- ØD1 Without finished bore
With finished bore
- ØD2 Without finished bore
With finished bore

Notes

- Weight and mass moments of inertia apply to maximum bore diameters.
- The article no. applies to elastic tires made of natural rubber.
- P2 = fitting space for dismounting the elastic tire

Ordering example

- ELPEX-B EBWN coupling, size 210
- Part 1: Bore 40H7mm, keyway to DIN 6885-1 and set screw
- Part 2: Bore 45H7 mm, keyway to DIN 6885-1 and set screw

Article no.: 2LC0210-4AA99-0AA0-Z L0W+M1A

¹⁾ To identify complete item numbers specifying the available finish boring options and – if necessary – further order options, please use our configurators on flender.com.

➤ For online configuration on flender.com, click on the item no.

TYPE EBWT

Sizes 105 ... 165

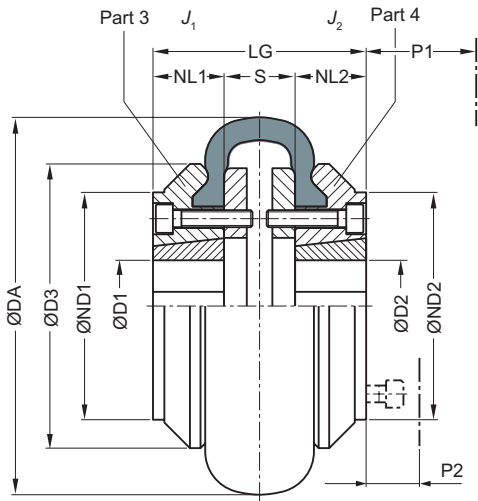

Variant AB

Sizes 190 ... 560

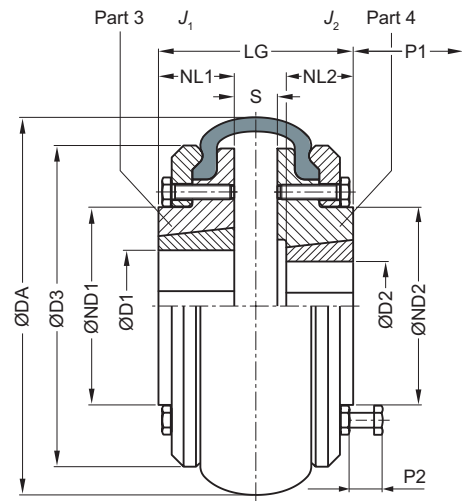

Variant AB

10

Sizes 105 ... 165

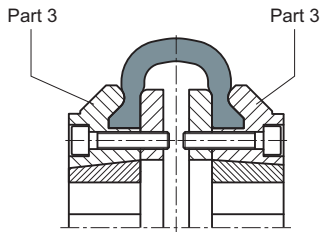

Variant A

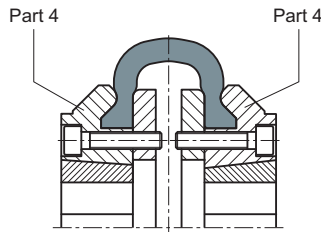

Variant B

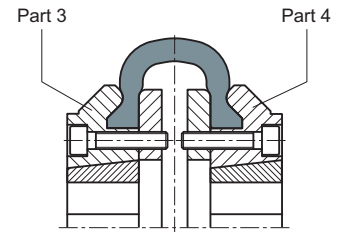

Variant AB

Sizes 190 ... 560

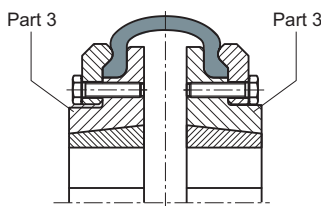

Variant A

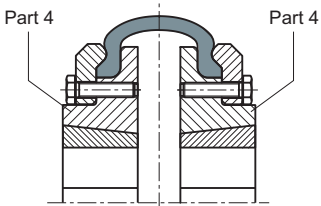

Variant B

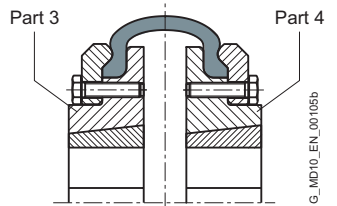

Variant AB

G_MD10_EN_00105b

Part 3: Screw connection for Taper clamping bush from the shaft end face side
 Part 4: Screw connection for Taper clamping bush from the machine-housing side

Size	Rated torque T_{KN} Nm	Part no.	Taper Clamping Bush Size	Dimensions in mm											Mass moment of inertia J_1/J_2 kgm ²	Article no. ¹⁾			Weight m kg
				D1, D2 Keyway DIN 6885-1		DA	ND1/ND2	NL1/NL2	D3	S	P1	P2	LG	Type					
				min.	max.									A		B	AB		
105	24	$\frac{3}{4}$	1008	10	25	104	-	22	82	22	29	35	66	0.0009	2LC0210-0AB	2LC0210-0AC	2LC0210-0AD	1.8	
135	66	$\frac{3}{4}$	1210	11	32	134	80	25	100	25	38	35	75	0.0019	2LC0210-1AB	2LC0210-1AC	2LC0210-1AD	2.4	
165	125	$\frac{3}{4}$	1610	14	42	165	103	25	125	33	38	35	83	0.0049	2LC0210-2AB	2LC0210-2AC	2LC0210-2AD	4	
190	250	$\frac{3}{4}$	2012	14	50	187	80	$\frac{32}{25}$	145	23	$\frac{42}{38}$	35	87	0.0085	2LC0210-3AB	2LC0210-3AC	2LC0210-3AD	5.4	
210	380	$\frac{3}{4}$	2517	16	60	211	98	$\frac{45}{32}$	168	25	$\frac{48}{42}$	35	$\frac{115}{89}$	0.017	2LC0210-4AB	2LC0210-4AC	2LC0210-4AD	8	
235	500	$\frac{3}{4}$	2517	16	60	235	108	46	188	27	48	35	119	0.019	2LC0210-5AB	2LC0210-5AC	2LC0210-5AD	12	
255	680	$\frac{3}{4}$	3020	25	75	254	$\frac{120}{113}$	$\frac{51}{45}$	216	27	$\frac{55}{48}$	35	$\frac{129}{117}$	0.05	2LC0210-6AB	2LC0210-6AC	2LC0210-6AD	14	
280	880	$\frac{3}{4}$	3020	25	75	280	134	52	233	25	55	35	129	0.075	2LC0210-7AB	2LC0210-7AC	2LC0210-7AD	22	
315	1350	$\frac{3}{4}$	3525	35	100	314	140	$\frac{66}{51}$	264	29	$\frac{67}{55}$	35	$\frac{161}{131}$	0.11	2LC0210-8AB	2LC0210-8AC	2LC0210-8AD	23	
360	2350	$\frac{3}{4}$	3525	35	100	359	178	65	311	32	67	35	162	0.26	2LC0211-0AB	2LC0211-0AC	2LC0211-0AD	38	
400	3800	$\frac{3}{4}$	4030	40	115	402	200	77	345	30	80	35	184	0.44	2LC0211-1AB	2LC0211-1AC	2LC0211-1AD	54	
470	6300	$\frac{3}{4}$	4535	55	125	470	210	89	398	46	89	35	224	0.8	2LC0211-2AB	2LC0211-2AC	2LC0211-2AD	72	
510	9300	$\frac{3}{4}$	4535	55	125	508	208	89	429	48	89	35	226	1.5	2LC0211-3AB	2LC0211-3AC	2LC0211-3AD	120	
560	11500	$\frac{3}{4}$	5040	70	125	562	224	102	474	55	92	35	259	2	2LC0211-4AB	2LC0211-4AC	2LC0211-4AD	120	

Configurable variants ¹⁾

- ØD1 Without finished bore
With finished bore
- ØD2 Without finished bore
With finished bore

Notes

- Weights and mass moments of inertia apply to couplings with Taper clamping bushes with maximum bore diameter.
- The article no. applies to elastic tires made of natural rubber.
- P1 = fitting space for offset screwdriver and ejector bolt for dismantling the Taper clamping bush
- P2 = fitting space for dismantling the elastic tire.

Ordering example

- ELPEX-B EBWT coupling, size 210, variant AB, including Taper clamping bushes
- Part 3: with Taper clamping bush, bore 60 mm
- Part 4: with Taper clamping bush, bore 40 mm

Article no.: 2LC0210-4AD99-0AA0-Z L1E+M0W

¹⁾ To identify complete item numbers specifying the available finish boring options and – if necessary – further order options, please use our configurators on flender.com.

➤ For online configuration on flender.com, click on the item no.

TYPE EBWZ

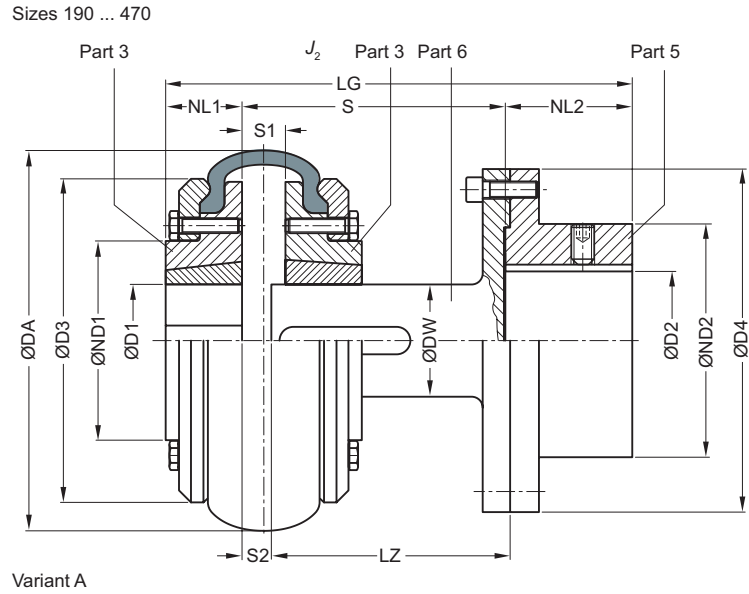

10

Sizes 105 ... 165

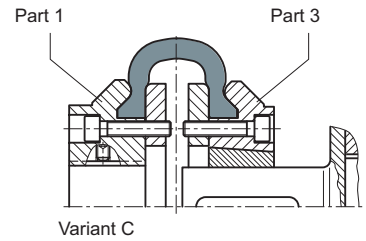
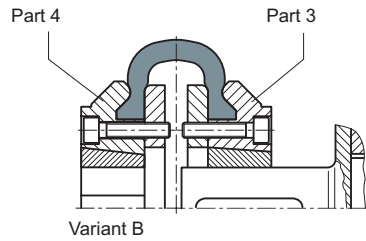
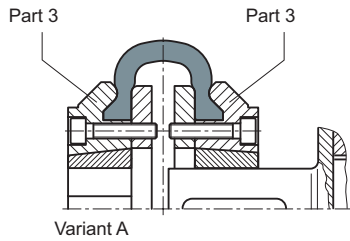

Sizes 190 ... 470

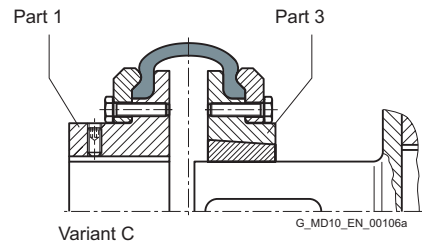
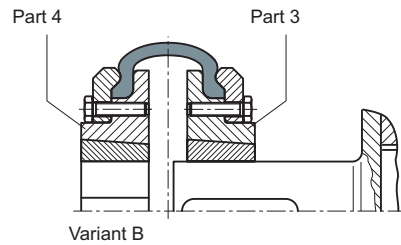
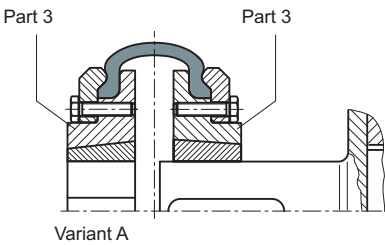

G_MD10_EN_00106a

Part 3: Screw connection for Taper clamping bush from the shaft end face side
 Part 4: Screw connection for Taper clamping bush from the machine-housing side

Size	Rated torque T_{KN} Nm	Dimensions in mm												Mass moment of inertia J_2 kgm ²	Article no. ¹⁾			Weight m kg	
		D1, D2 Keyway DIN 6885-1		DA	ND2	D4	DW	NL2	LZ	S		S1	S2		Type	A	B		C
		min.	max.							min.	max.								
105	24	-	42	104	70	95	25	45	96 133	100 140	116 156	22	6	0.0027	2LC0210-0AG	2LC0210-0AH	2LC0210-0AJ	3.3	
135	66	-	55	134	90	125	32	50	93 133	100 140	116 156	25	9	0.0085	2LC0210-1AG	2LC0210-1AH	2LC0210-1AJ	5.4	
165	125	-	55	165	90	125	32	50	93 133	100 140	124 164	33	9	0.012	2LC0210-2AG	2LC0210-2AH	2LC0210-2AJ	6.2	
190	250	-	75	187	125	180	48	80	93.5 133.5	100 140	114 154	23	9	0.046	2LC0210-3AG	2LC0210-3AH	2LC0210-3AJ	16	
210	380	-	75	211	125	180	48	80	133.5 173.5	140 180	156 196	25	9	0.053	2LC0210-4AG	2LC0210-4AH	2LC0210-4AJ	17	
235	500	-	75	235	125	180	48	80	133.5 173.5	140 180	158 198	27	9	0.056	2LC0210-5AG	2LC0210-5AH	2LC0210-5AJ	25	
255	680	-	90	254	150	225	60	100	133.5 173.5	140 180	158 198	27	9	0.15	2LC0210-6AG	2LC0210-6AH	2LC0210-6AJ	29	
280	880	-	90	280	150	225	60	100	133.5 173.5	140 180	156 196	25	9	0.17	2LC0210-7AG	2LC0210-7AH	2LC0210-7AJ	33	
315	1350	46	100	314	165	250	80	110	134.5 174.5	140 180	160 200	29	9	0.28	2LC0210-8AG	2LC0210-8AH	2LC0210-8AJ	40	
360	2350	46	100	359	165	250	80	110	134.5 174.5	140 180	163 203	32	9	0.43	2LC0211-0AG	2LC0211-0AH	2LC0211-0AJ	48	
400	3800	51	110	402	180	280	90	120	223.5	230	250	30	10	0.88	2LC0211-1AG	2LC0211-1AH	2LC0211-1AJ	73	
470	6300	51	120	470	200	315	100	140	207.5	214	250	46	10	0.97	2LC0211-2AG	2LC0211-2AH	2LC0211-2AJ	104	

Configurable variants¹⁾

- ØD1 Without finished bore
With finished bore

- ØD2 Without finished bore
With finished bore

- S min. 100 mm
140 mm
180 mm

Notes

- Dimensions D1, ND1, NL1, J1 and fitting space for dismounting elastic tire and Taper clamping bush, see types EBWN or EBWT, **Page 10/7** or **Page 10/8**
- The article no. applies to elastic tires made of natural rubber.
- Mass moment of inertia J_2 and weight m as total of part 3, part 5 and part 6 with maximum bore diameter.

Ordering example

- ELPEX-B EBWZ coupling, size 360
 - variant C, for fitting length S min. = 190 mm
 - Part 1: Bore 65H7 mm, keyway to DIN 6885-1 and set screw
 - Part 5: Bore 70H7 mm, keyway to DIN 6885-1 and set screw
- Article no.: 2LC0211-0AJ99-0AC0-Z L1F+M1G

¹⁾ To identify complete item numbers specifying the available finish boring options and – if necessary – further order options, please use our configurators on flender.com.

↗ For online configuration on flender.com, click on the item no.

SPARE AND WEAR PARTS

Elastic tire

Size	Article No.		Chloroprene rubber	
	Natural rubber Identification 048	Weight kg	Identification 068 FRAS	Weight kg
105	2LC0210-0WA00-0AA0	0.1	2LC0210-0WA00-0AA0-Z K01	0.1
135	2LC0210-1WA00-0AA0	0.2	2LC0210-1WA00-0AA0-Z K01	0.2
165	2LC0210-2WA00-0AA0	0.4	2LC0210-2WA00-0AA0-Z K01	0.4
190	2LC0210-3WA00-0AA0	0.5	2LC0210-3WA00-0AA0-Z K01	0.5
210	2LC0210-4WA00-0AA0	0.8	2LC0210-4WA00-0AA0-Z K01	0.8
235	2LC0210-5WA00-0AA0	1	2LC0210-5WA00-0AA0-Z K01	1
255	2LC0210-6WA00-0AA0	1.2	2LC0210-6WA00-0AA0-Z K01	1.2
280	2LC0210-7WA00-0AA0	1.4	2LC0210-7WA00-0AA0-Z K01	1.4
315	2LC0210-8WA00-0AA0	2.6	2LC0210-8WA00-0AA0-Z K01	2.6
360	2LC0211-0WA00-0AA0	2.9	2LC0211-0WA00-0AA0-Z K01	2.9
400	2LC0211-1WA00-0AA0	3.1	2LC0211-1WA00-0AA0-Z K01	3.1
470	2LC0211-2WA00-0AA0	5.3	2LC0211-2WA00-0AA0-Z K01	5.3
510	2LC0211-3WA00-0AA0	7.8	2LC0211-3WA00-0AA0-Z K01	7.8
560	2LC0211-4WA00-0AA0	10.8	2LC0211-4WA00-0AA0-Z K01	10.8
630	2LC0211-5WA00-0AA0	12.4	2LC0211-5WA00-0AA0-Z K01	12.4

10

Note

- The elastic tires are wear parts.
The service life depends on the operating conditions.

HIGHLY FLEXIBLE COUPLINGS – ELPEX-S SERIES



General	11/3
Benefits	11/3
Application	11/3
Design and configurations	11/4
Function	11/6
Configuration	11/6
Technical specifications	11/8

Type ESN	11/14

Type ESNR	11/16

Type ESD	11/18

Type ESDR	11/19

Type ESNW	11/20

Type ESDW	11/21

Type EST	11/22

Spare and wear parts	11/23



GENERAL



Coupling suitable for use in potentially explosive atmospheres.

Complies with the current ATEX Directive for:

CE  II 2G Ex h IIC T4 ... T3 Gb X

 II 2D Ex h IIIC T120 °C ... 160 °C Db X

 I M2 Ex h Mb X

(Type EST is not available in Ex version.)

ELPEX-S couplings are highly torsionally flexible and because of their low torsional stiffness and damping capacity are especially suitable for coupling machines with a highly non uniform torque pattern.

Standard ELPEX-S coupling types are designed as flange-shaft-connections or shaft-shaft connections.

Application-related types can be implemented on request.

Benefits

The ELPEX-S coupling is suitable for horizontal and vertical mounting positions or mounting at any required angle. The coupling parts can be arranged as required on the shafts to be connected.

ELPEX-S couplings are especially suitable for reversing operation or operation with changing directions of load.

The rubber disk elements are fitted virtually without backlash and give the coupling linear torsional stiffness, i.e. the torsion stiffness remains constant even when the load on the coupling increases.

There are 4 different rubber element versions with different grades of torsional stiffness available for each size from stock.

Application

The ELPEX-S coupling is available as a catalog standard in 12 sizes with rated torques of between 330 Nm and 63000 Nm.

The coupling is suitable for ambient temperatures of between -40 °C and +120 °C.

The ELPEX-S coupling is frequently used for diesel motor drives or reciprocating compressor drives.

On certain types the flexible rings can be changed without having to move the coupled machines.

If substantial overload occurs, the rubber disk element of the coupling is irreparably damaged, the coupling throws the load and thus limits the overload for particular operating conditions. The coupling can be inserted and fitted blind e.g. in a bell housing.

There are outer flanges with different connection dimensions available for each coupling size.

Because the different rubber versions enable the torsional stiffness to be adjusted to meet requirements, the coupling is also suitable for drives which require a specific and preferably precalculated torsional vibration behavior setting.

GENERAL

Design and configurations

The rubber disk element is vulcanized onto a flange on the inside diameter. The flange can mount e.g. a Taper clamping bush or a hub. On its outer diameter the rubber disk element has driving teeth, which are inserted into the outer flange. The torque is transmitted positively between the rubber disk element and the outer flange.

In the type for shaft-shaft connection the outer flange is screwed to a flange hub mounted on a machine shaft.

Materials

	Type EST	Types ESN. and ESD.
Rubber disk element	EN-GJL-250 grey cast iron/ elastomer	EN-GJL-400 spheroidal graphite cast iron/elastomer
Hubs, part 1, part 2	Steel	Steel
Outer flange	Cast aluminum Zn10Si8Mg Sizes 680 and 770 of spheroidal graphite cast iron EN-GJS-500	Cast aluminum Zn10Si8Mg Sizes 680 and 770 of spheroidal graphite cast iron EN-GJS-500

Elastomer materials of the rubber disk element

Material/ description	Hardness ShoreA	Marking	Ambient temperature
Natural-synthetic rubber mixture	50 ° ... 55 °	WN	-40 °C ... +80 °C
	60 ° ... 65 °	NN	-40 °C ... +80 °C
	70 ° ... 75 °	SN	-40 °C ... +80 °C
Silicone rubber	55 ° ... 65 °	NX	-40 °C ... +120 °C

11

ELPEX-S coupling types

Type	Description
ESN	Coupling with hub, long or short version
ESD	Coupling with hub, with two rubber disk elements
ESNR	Coupling with hub, rubber disk element radially dismountable
ESDR	Coupling with hub with two rubber disk elements; rubber disk elements radially dismountable
ESNW	Coupling designed as a shaft-shaft connection with a rubber disk element; rubber disk element radially dismountable
ESDW	Coupling designed as a shaft-shaft connection with two rubber disk elements; rubber disk element radially dismountable
EST	Coupling suitable for mounting a Taper clamping bush

Further application-related coupling types are available. Dimension sheets for and information on these are available on request.

The following versions have already been implemented a number of times:

- ELPEX-S coupling with brake drum, brake disk or flywheel mass
- ELPEX-S coupling with axial backlash limiter
- ELPEX-S coupling with adapter
- ELPEX-S coupling with bearing for mounting a cardan shaft
- ELPEX-S coupling for engaging/disengaging during standstill
- ELPEX-S coupling as part of a coupling combination
- ELPEX-S coupling with fail-safe device

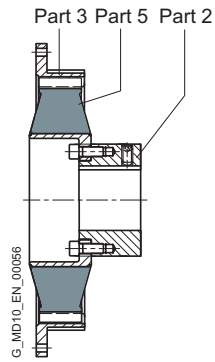

Type ESN – long version

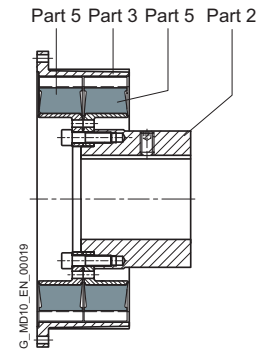

Type ESD

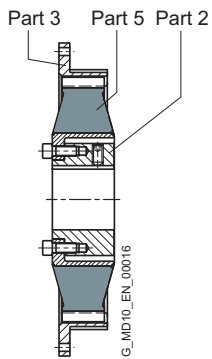

Type ESN – short version

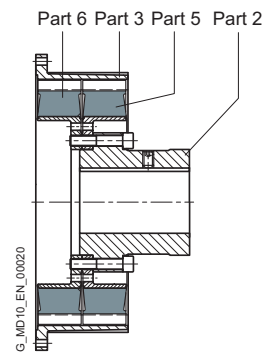

Type ESDR

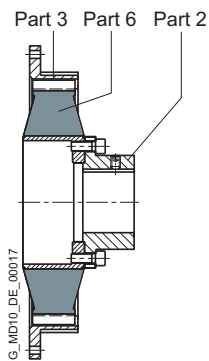

Type ESNR

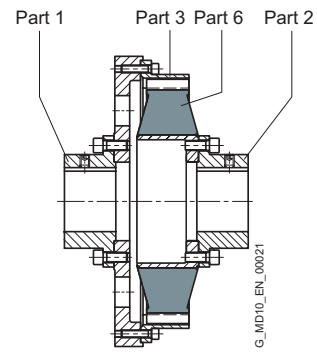

Type ESNW

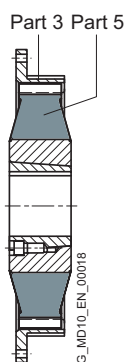

Type EST

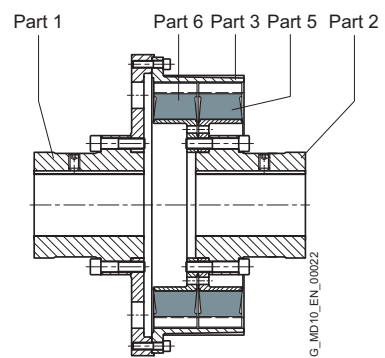

Type ESDW

GENERAL

Fail-safe device of ELPEX-S coupling

The ELPEX-S coupling can also be designed with a fail-safe device. If the rubber disk element fails, the coupling can continue operating in emergency mode for a short time. This option is frequently required e.g. in the case of marine drives.

If the rubber disk element fails, cams transmit the torque from the inner and outer parts of the fail-safe device.

In normal operation the torsion angle of the rubber disk element is smaller than the gap between the cams, so there is no metal-metal contact.

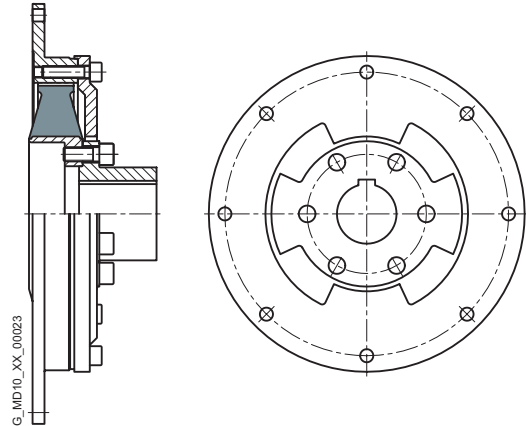

Function

The ELPEX-S coupling's transmission characteristic is determined essentially by the rubber disk element. The torque is transmitted positively between the rubber disk element and the outer flange.

The outer flange can be bolted to e.g. a diesel motor or compressor flywheel.

11

Configuration

Coupling selection

The ELPEX-S coupling is especially suitable for rough operating environments. An application factor lower than that in the **chapter introduction** is therefore sufficient for all applications.

In the case of machines which excite torsional vibration, Flender urgently recommends carrying out a torsional vibration calculation or measuring the coupling load occurring in the drive.

Coupling load in continuous operation

Application factor FB	Torque characteristic of the driven machine		
	uniform with moderate shock loads	non uniform	very rough
Electric motors, hydraulic motors, gas and water turbines	1.0	1.3	1.4
Internal-combustion engines	1.3	1.4	1.6

Examples of torque characteristic in driven machines:

- uniform with moderate shock loads: Generators, fans, blowers
- non uniform: Reciprocating compressors, mixers, conveyor systems
- very rough: crushers, excavators, presses, mills

Temperature factor FT		Temperature T_a on the coupling									
Coupling	Rubber version	Elastomer material	-40 up to -30 °C	-30 up to +50 °C	up to 60 °C	up to 70 °C	up to 80 °C	up to 90 °C	up to 100 °C	up to 110 °C	up to 120 °C
ELPEX-S	SN, NN, WN	NR	1.1	1.0	1.25	1.40	1.60	-	-	-	-
	NX	VMQ	1.1	1.0	1.0	1.0	1.0	1.1	1.25	1.4	1.6

NR = Natural-synthetic rubber mixture
 VMQ = Silicone rubber

$$\text{Coupling size } T_{KN} \geq T_N \cdot FB \cdot FT$$

Coupling load under maximum and overload conditions

The maximum torque is the highest load acting on the coupling in normal operation.

Maximum torques at a frequency of up to 25 times an hour are permitted and must be lower than the maximum coupling torque. Examples of maximum torque conditions are: Starting operations, stopping operations or usual operating conditions with maximum load.

$$T_{K_{\max}} \geq T_{\max} \cdot FT$$

Overload torques are maximum loads which occur only in combination with special, infrequent operating conditions. Examples of overload torque conditions are: Motor short circuit, emergency stop or blocking because of component breakage. Overload torques at a frequency of once a month are permitted and must be lower than the maximum overload torque of the coupling. The overload condition may last only a short while, i.e. fractions of a second.

$$T_{K_{OL}} \geq T_{OL} \cdot FT$$

Coupling load due to dynamic torque load

Applying the frequency factor FF, the dynamic torque load must be lower than the coupling fatigue torque.

Dynamic torque load





$$T_{KW} \geq T_W \cdot FF \cdot FF$$

Frequency of the dynamic torque load

$$f_{err} \leq 10 \text{ Hz frequency factor } FF = 1.0$$

Frequency of the dynamic torque load

$$f_{err} > 10 \text{ Hz frequency factor } FF = \sqrt{(f_{err}/10 \text{ Hz})}$$

-  Operation in potentially explosive environments is subject to the following restriction:
Operation with low fatigue load
-  The fatigue torque TKW must be reduced by 70 %. In these particular operating conditions the coupling satisfies the requirements of temperature class T4 D120 °C.
Operation with medium fatigue load
-  The fatigue torque T_{KW} must be reduced by 50 %. In these particular operating conditions the coupling satisfies the requirements of temperature class T3 D160 °C.
-  Type EST is not permitted for application in potentially explosive environments.

Checking the maximum speed

The following must apply to all load situations: $n_{K_{\max}} \geq n_{\max}$
The maximum speed of a size depends only on the size of the outer flange (part 3).

Checking permitted shaft misalignment and restorative forces

For all load situations, the actual shaft misalignment must be less than the permitted shaft misalignment.

Checking bore diameter, mounting geometry and coupling design

The check must be made on the basis of the dimension tables.

On request, couplings with adapted geometry can be provided.

Checking shaft-hub connection

For any information on this, please refer to [Page E/20](#).

Checking temperature and chemically aggressive environment

The permitted coupling temperature is specified in the Temperature Factor FT table. In the case of chemically aggressive environments, please consult the manufacturer.

GENERAL

Technical specifications

Performance data for rubber disk elements made of a mix of natural and synthetic rubber

Type	Size	Rubber version	Rated torque	Maximum torque	Overload torque	Fatigue torque	dynamic torsional stiffness	Motor flange SAE J620d Size	Maximum speed n_{max} rpm
			T_{KN} Nm	T_{Kmax} Nm	T_{KOL} Nm	T_{KW} Nm	C_{Tdyn} Nm/rad		
ESN . EST	220	WN	330	660	750	165	1600	6.5	4200
		NN	360	720	900	180	2500	7.5	4200
		SN	400	800	1000	200	4200	8 10	4200 3600
ESN . EST	265	WN	500	1000	1250	250	2400	8	4200
		NN	600	1200	1800	300	3600	10	3600
		SN	700	1400	2100	350	6100	11.5	3500
ESN . EST	290	WN	800	1600	2000	400	3600	10	3600
		NN	900	1800	2700	450	5000	11.5	3500
		SN	1000	2000	3000	500	7500		
ESN . EST	320	WN	1200	2400	3000	600	8000	11.5	3500
		NN	1350	2700	3600	650	10000	14	3000
		SN	1550	3100	4200	750	13500		
ESN . EST	360	WN	1800	3600	4500	900	8500	11.5	3200
		NN	2000	4000	5400	1000	13000	14	3000
		SN	2500	5000	7500	1250	22000		
ESN . EST	420	WN	3100	6200	7700	1500	16000	14	3000
		NN	3450	6900	10000	1700	30000	16	2600
		SN	4200	8400	12600	2100	45000	18	2300
ESN . EST	465	WN	4600	9200	10000	2300	35000	14	3000
		NN	5200	10400	15600	2600	56000	16	2600
		SN	6300	12600	18900	3100	100000	18	2300
ESN .	520	WN	6200	12400	14000	3100	38000	18	2300
		NN	7000	14000	21000	3500	75000	21	2000
		SN	7800	15600	23400	3900	110000		
ESD .	520	WN	12400	24800	28000	6200	76000	18	2300
		NN	14000	28000	42000	7000	150000	21	2000
		SN	15600	31200	46800	7800	220000		
ESN .	560	WN	8000	16000	18000	4200	55000	18	2300
		NN	9000	18000	27000	4800	100000	21	2000
		SN	10000	20000	30000	5500	190000		
ESD .	560	WN	16000	32000	36000	8400	110000	18	2300
		NN	18000	36000	54000	9600	200000	21	2000
		SN	20000	40000	60000	11000	380000		

Performance data for rubber disk elements made of a mix of natural and synthetic rubber											
Type	Size	Rubber version	Rated torque	Maximum torque	Overload torque	Fatigue torque	dynamic torsional stiffness	Motor flange SAE J620d Size	Maximum speed max rpm		
			T_{KN} Nm	T_{Kmax} Nm	T_{KOL} Nm	T_{KW} Nm	C_{Tdyn} Nm/rad				
ESN .	580	WN	11000	22000	28000	5500	75000	18	2300		
		NN	12500	25000	37000	6250	120000				
		SN	14000	28000	42000	7000	210000	21	2000		
ESD .	580	WN	22000	44000	56000	11000	150000			21	2000
		NN	25000	50000	74000	12500	240000				
		SN	28000	56000	84000	14000	420000	24	1800		
ESN .	680	WN	16000	32000	40000	8000	150000			21	2000
		NN	18000	36000	54000	9000	250000				
		SN	20000	40000	60000	10000	450000	24	1800		
ESD .	680	WN	32000	64000	80000	16000	300000			21	2000
		NN	36000	72000	108000	18000	500000				
		SN	40000	80000	120000	20000	900000	24	1800		
ESN .	770	WN	25000	50000	75000	12500	250000			similar to DIN 6288	1500
		NN	28000	56000	84000	14000	400000				
		SN	31500	63000	94000	15000	700000				
ESD .	770	WN	50000	100000	150000	25000	500000	similar to DIN 6288	1300		
		NN	56000	112000	168000	28000	800000				
		SN	63000	126000	189000	30000	1400000				

Torsional stiffness and damping

Torsional stiffness depends on the ambient temperature and the frequency and amplitude of the torsional vibration excitation. More precise torsional stiffness and damping parameters on request.

With flexible couplings the manufacturing process of the rubber elements and their aging primarily influence the stiffness value C_{Tdyn} .

For this reason calculation must be made with a tolerance for the dynamic stiffness of $\pm 20\%$. The specified damping coefficient Ψ is a minimum value with the result that the damping performance of the coupling corresponds at least to the specified value.

GENERAL

Technical specifications

Power ratings of the rubber disk elements made of silicone rubber											
Type	Size	Rubber version	Rated torque		Maximum torque		Overload torque		Fatigue torque		Dynamic torsional stiffness for 100 % load C_{Tdyn} kNm/rad
			T_{KN} Nm		T_{Kmax} Nm		T_{KOL} Nm		$T_{KW}(10\text{ Hz})$ Nm		
ESN .	220	NX	200		300		400		87		1.3
ESN .	265	NX	300		450		600		133		2.4
ESN .	290	NX	500		750		1000		213		4.2
ESN .	320	NX	770		1150		1530		320		9.2
ESN .	360	NX	1200		1800		2400		480		10
ESN .	420	NX	2000		3000		4000		800		23
ESN .	465	NX	3000		4500		6000		1200		60
ESN .	520	NX	4100		6100		8200		1600		65
ESD .	520	NX	8200		12300		16400		3200		130
ESN .	560	NX	5000		7500		10000		2200		100
ESD .	560	NX	10000		15000		20000		4400		200
ESN .	580	NX	6500		9750		13000		2667		160
ESD .	580	NX	13000		19500		26000		5867		310
ESN .	680	NX	10000		15000		20000		4000		280
ESD .	680	NX	20000		30000		40000		8000		550
ESN .	770	NX	15000		22500		30000		6000		620
ESD .	770	NX	30000		45000		60000		12000		1230

11

Torsional stiffness

The dynamic torsional stiffness of the silicone rubber elements is load-dependent and increases in proportion to the load. The values specified in the selection table represent 100 % loading. The following table shows the correction factors for different rated loads.

$$C_{Tdyn} = C_{Tdyn\ 100\ \%} \cdot FK C$$

Correction factor FK C	Load T_N / T_{KN}						
	20%	50%	60%	70%	80%	100%	150%
	0.59	0.75	0.79	0.83	0.88	1	1.5

Torsional stiffness also depends on the ambient temperature and the frequency and amplitude of the torsional vibration excitation. More precise torsional stiffness and damping parameters on request.

Damping coefficient

Damping coefficient of the rubber versions		
Rubber version	Hardness ShoreA	Damping coefficient Ψ
WN	55 ° ± 5 °	0.80
NN	65 ° ± 5 °	1.15
SN	75 ° ± 5 °	1.25
NX	60 ° ± 5 °	1.15

With flexible couplings the manufacturing process of the rubber elements and their aging primarily influence the stiffness value C_{Tdyn} . For this reason calculation must be made with a tolerance for the dynamic stiffness of ± 20 %. The specified damping coefficient Ψ is a minimum value with the result that the damping performance of the coupling corresponds at least to the specified value.

Permitted shaft misalignment

The permitted shaft misalignment depends on the operating speed. As the speed increases, lower shaft misalignment values are permitted.

For fitting, the maximum gap dimension of $S_{max.} = S + \Delta S$ and the minimum gap dimension of $S_{min.} = S - \Delta S$ are permitted.

Size	Assembly Shaft distance ΔS mm	Permitted shaft misalignment at $n = 1500$ rpm		
		Axial ΔK_a mm	Radial ΔK_r mm	Angle ΔK_w degree
220	1.3	0.2	1.2	0.5
265	1.3	0.2	1.2	0.5
290	1.5	0.2	1.2	0.5
320	1.5	0.2	1.2	0.5
360	1.5	0.2	1.2	0.5
420	1.5	0.3	1.3	0.4
465	1.7	0.3	1.3	0.4
520	1.7	0.3	1.4	0.4
560	1.7	0.3	1.4	0.4
580	1.8	0.4	1.5	0.3
680	1.8	0.4	1.5	0.3
770	2.0	0.5	1.5	0.3

The correction factors for different speeds are specified in the following table.

The maximum speed for the respective coupling size and type must be noted!

$$\Delta K_{perm} = \Delta K_{1500} \cdot FKV$$

	Speed in rpm			
	500	1000	1500	3000
Correction factor FKV	1.2	1.1	1.0	0.7

GENERAL

Variants of the outer flange

The outer flange of sizes 220 to 680 is designed to fit the connection dimensions of the SAE J620d standard. The centering depth on the connection flange of the machine should be between 4 mm and 6.4 mm maximum.

Type	Size	Flange connection size	Figure	
ESN	220	6.5	1	
ESN	220	7.5	2	
ESN, ESNR	265	8		
	360	11.5		
	465	14		
	580	18		
ESN, ESNR	680	21	3	
	ESN	220		8, 10
	ESN, ESNR	265		10, 11.5
		290		all
		320		all
		360		14
		420		all
		465		16, 18
		520		all
		560		all
580		21		
680	24			
ESNR	770	all	4	
ESD, ESDR	520	all		
	560	all		
ESD, ESDR	580	all	5	
	680	21		
ESD, ESDR	680	24	6	
ESDR	770	all		

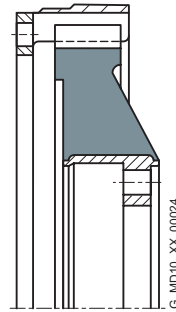

Figure 1

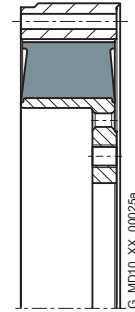

Figure 2

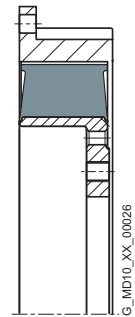

Figure 3

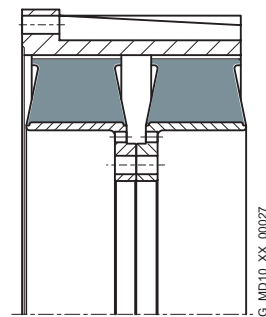

Figure 4

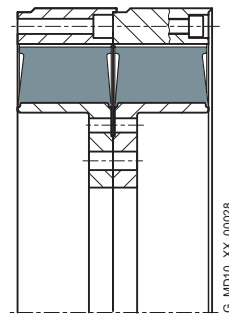

Figure 5

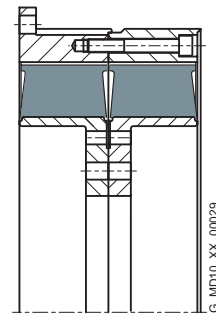
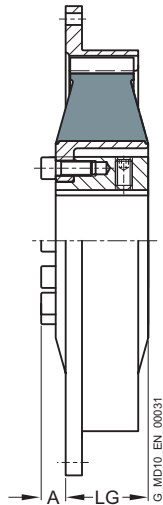
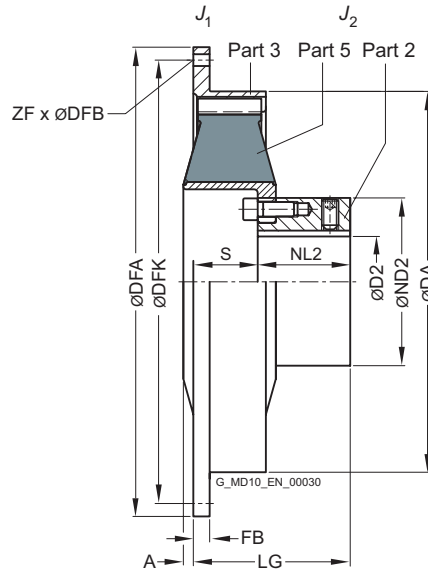

Figure 6

TYPE ESN



Short version



Long version

11

Size	Dimensions in mm											Mass moment of inertia		Article no. ¹⁾		Weight m kg				
	D2 Keyway DIN 6885 max.	DA	ND2	NL2	short version		long version			Flange connection dimensions					J ₁ kgm ²		J ₂ kgm ²	Type		
					A	LG	A	S	LG	SAE size	DFA	DFK	FB	ZF				DFB	short version	long version
220	60	222	98	54	-	-	0	49	103	6.5	215.9	200.0	6	6	8.5	0.008	0.01	-	2LC0220-0AB0	5.8
		237						40	94	7.5	241.3	222.3	33	8	8.5	0.011		-	2LC0220-0AB0	6.1
		222						40	94	8	263.5	244.5	8	6	10.5	0.011		-	2LC0220-0AB0	6.4
		222						40	94	10	314.3	295.3	8	8	10.5	0.017		-	2LC0220-0AB0	6.9
265	65	263	118	65	15	74	3	39	104	8	263.5	244.5	33	6	0.011	0.022	2LC0220-1AA0	2LC0220-1AB0	6.6	
										10	314.3	295.3	10	8	10.5		0.017	2LC0220-1AA0	2LC0220-1AB0	6.9
										11.5	352.4	333.4	10	8	0.024		2LC0220-1AA0	2LC0220-1AB0	7.2	
290	65	290	118	70	18	58	6	36	106	10	314.3	295.3	16	8	0.026	0.026	2LC0220-2AA0	2LC0220-2AB0	9.2	
										11.5	352.4	333.4	16	8	0.036		2LC0220-2AA0	2LC0220-2AB0	10.5	
320	80	318	140	87	15	96	2	70	157	11.5	352.4	333.4	16	8	10.5	0.062	0.061	2LC0220-3AA0	2LC0220-3AB0	19
										14	466.7	438.2	16	8	13	0.18		2LC0220-3AA0	2LC0220-3AB0	20.5
360	90	353.5	160	105	29	92	13	56	161	11.5	352.4	333.4	54	8	10.5	0.065	0.13	2LC0220-4AA0	2LC0220-4AB0	24.5
										14	466.7	438.2	15	8	13	0.18		2LC0220-4AA0	2LC0220-4AB0	27.5
										14	466.7	438.2	18	8	13	0.22		2LC0220-5AA0	2LC0220-5AB0	36
420	100	420	185	102	26	92	10	72	174	16	517.5	489.0	18	8	13	0.32	0.32	2LC0220-5AA0	2LC0220-5AB0	38
										18	571.5	542.9	18	6	17	0.47		2LC0220-5AA0	2LC0220-5AB0	40

Configurable variants ¹⁾

- ØD2 Without finished bore
 With finished bore

- Rubber version WN
 NN
 SN
 NX

¹⁾ To identify complete item numbers specifying the available finish boring options and – if necessary – further order options, please use our configurators on flender.com.

➤ For online configuration on flender.com, click on the item no.

Size	Dimensions in mm													Mass moment of inertia		Article no. ¹⁾		Weight <i>m</i> kg		
	D2 Keyway DIN 6885 max.	DA	ND2	NL2	short version		long version			Flange connection dimensions									<i>J</i> ₁ kgm ²	<i>J</i> ₂ kgm ²
					A	LG	A	S	LG	SAE size	DFA	DFK	FB	ZF	DFB	short version	long version			
465	120	465	222	125	33	92	2	39	164	14	466.7	438.2	85	8	13	0.31	0.58	2LC0220-6AA0	2LC0220-6AB0	56
										16	517.5	489.0	27	8	13	0.41		2LC0220-6AA0	2LC0220-6AB0	57
										18	571.5	542.9	18	6	17	0.52		2LC0220-6AA0	2LC0220-6AB0	61
520	165	514	250	142	16	159	0	83	225	18	571.5	542.9	18	12	17	0.48	0.93	2LC0220-7AA0	2LC0220-7AB0	55
										21	673.1	641.4	18	12	17	0.95		2LC0220-7AA0	2LC0220-7AB0	60
560	200	560	320	140	30	130	2.5	83	223	18	571.5	542.9	35	12	17	0.85	1.2	2LC0220-8AA0	2LC0220-8AB0	69
										21	673.1	641.4	20	12	17	1.8		2LC0220-8AA0	2LC0220-8AB0	78
580	200	580	316	200	23	215	0	100	300	18	571.5	542.9	104	12	17	0.77	1.8	2LC0221-0AA0	2LC0221-0AB0	100
										21	673.1	641.4	26	12	17	1.2		2LC0221-0AA0	2LC0221-0AB0	105
680	220	682	380	210	24	232	0	102	312	21	673.1	641.4	85	12	17	4.1	5.3	2LC0221-1AA0	2LC0221-1AB0	205
										24	733.4	692.2	20	12	21	5.3		2LC0221-1AA0	2LC0221-1AB0	215

Configurable variants ¹⁾

- ØD2 Without finished bore
 With finished bore

- Rubber version WN
 NN
 SN
 NX

Notes

- The rubber disk element cannot be dismantled until the machines have been moved.
- Weight and mass moments of inertia apply to maximum bore diameters.

Ordering example

- ELPEX-S ESN coupling, size 520, WN rubber element version
- Bore ØD2 = 150H7 mm, with keyway to DIN 6885 and set screw, outer flange to SAE J620d size 21

Short version article no.: 2LC0220-7AA09-1JA0-Z M1W

Long version article no.: 2LC0220-7AB09-1JA0-Z M1W

¹⁾ To identify complete item numbers specifying the available finish boring options and – if necessary – further order options, please use our configurators on fender.com.

➤ For online configuration on fender.com, click on the item no.

TYPE ESNR

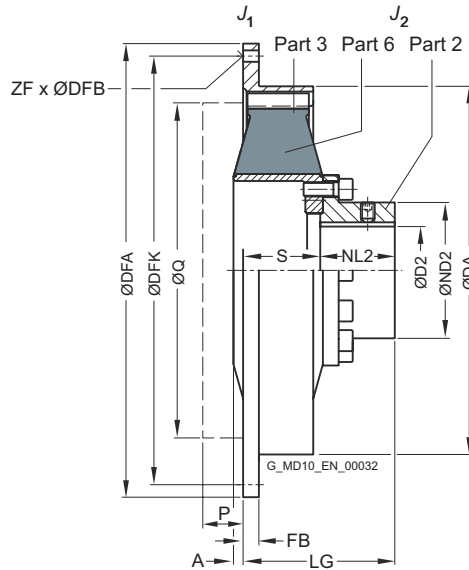

Size	Dimensions in mm										Flange connection dimensions					Mass moment of inertia		Article no. ¹⁾	Weight m kg
	D2 Keyway DIN 6885 max.	DA	ND2	NL2	S	A	P	Q	LG	SAE size	DFA	DFK	FB	ZF	DFB	J ₁ kgm ²	J ₂ kgm ²		
265	50	263	78	65	42	-	10	225	107	8	263.5	244.5	33	6	10.5	0.011	0.022	2LC0220-1AC0	5.0
										10	314.3	295.3	10	8		0.017		2LC0220-1AC0	5.3
										11.5	352.4	333.4	10	8		0.024		2LC0220-1AC0	5.6
290	50	290	78	65	59	2	15	276	124	10	314.3	295.3	16	8	10.5	0.026	0.026	2LC0220-2AC0	8.1
										11.5	352.4	333.4	16	8		0.036		2LC0220-2AC0	8.4
320	65	318	98	87	74	0	20	310	161	11.5	352.4	333.4	16	8	10.5	0.062	0.061	2LC0220-3AC0	13.5
										14	466.7	438.2	16	8		0.18		2LC0220-3AC0	16
360	85	353.5	123	88	77	9	28	314	165	11.5	352.4	333.4	54	8	10.5	0.065	0.13	2LC0220-4AC0	20
										14	466.7	438.2	15	8		0.18		2LC0220-4AC0	23
420	100	420	155	85	93	6	28	409	178	14	466.7	438.2	18	8	13	0.22	0.32	2LC0220-5AC0	31
										16	517.5	489.0	18	8		0.32		2LC0220-5AC0	32
										18	571.5	542.9	18	6		0.47		2LC0220-5AC0	35
465	130	465	190	119	88	-	15	409	207	14	466.7	438.2	85	8	13	0.31	0.58	2LC0220-6AC0	41
										16	517.5	489.0	27	8		0.41		2LC0220-6AC0	42
										18	571.5	542.9	18	6		0.52		2LC0220-6AC0	45

Configurable variants ¹⁾

- ØD2 Without finished bore
 With finished bore
- Rubber version WN
 NN
 SN
 NX

¹⁾ To identify complete item numbers specifying the available finish boring options and – if necessary – further order options, please use our configurators on flender.com.

↗ For online configuration on flender.com, click on the item no.

Size	Dimensions in mm															Mass moment of inertia		Article no. ¹⁾	Weight <i>m</i> kg
	D2 Keyway DIN 6885 max.	DA	ND2	NL2	S	A	P	Q	LG	Flange connection dimensions						<i>J</i> ₁ kgm ²	<i>J</i> ₂ kgm ²		
										SAE size	DFA g7	DFK	FB	ZF	DFB				
520	150	514	227	162	85	-	10	498	247	18	571.5	542.9	18	12	17	0.48	0.93	2LC0220-7AC0	59
										21	673.1	641.4	18	12	17	0.95			
560	150	560	240	180	99	-	10	498	279	18	571.5	542.9	35	12	17	0.85	1.2	2LC0220-8AC0	75
										21	673.1	641.4	20	12	17	1.8			
580	160	580	240	200	102	-	10	498	302	18	571.5	542.9	104	12	17	0.77	1.8	2LC0221-0AC0	80
										21	673.1	641.4	26	12	17	1.2			
680	200	682	300	210	102	-	10	584	312	21	673.1	641.4	85	12	17	4.1	5.3	2LC0221-1AC0	155
										24	733.4	692.2	20	12	21	5.3			
770	260	780	390	255	134	-	10	750	389	-	860.0	820.0	26	32	21	10.7	12	2LC0221-2AC0	330
										-	920.0	880.0	27	32	21	15.4			
										-	995.0	950.0	27	32	21	20.5			

Configurable variants¹⁾

- ØD2 Without finished bore
 With finished bore

- Rubber version WN
 NN
 SN
 NX

Notes

- Weight and mass moments of inertia apply to maximum bore diameters.
- P, Q = required space for radial dismounting of the rubber disk element.

Ordering example

- ELPEX-S ESNR coupling, size 320, WN rubber element version
- Bore ØD2 = 50H7 mm, with keyway to DIN 6885 and set screw, outer flange to SAE J620d size 14

Article no.: 2LC0220-3AC09-1FA0-Z M1C

¹⁾ To identify complete item numbers specifying the available finish boring options and – if necessary – further order options, please use our configurators on fender.com.
 ↗ For online configuration on fender.com, click on the item no.

TYPE ESD

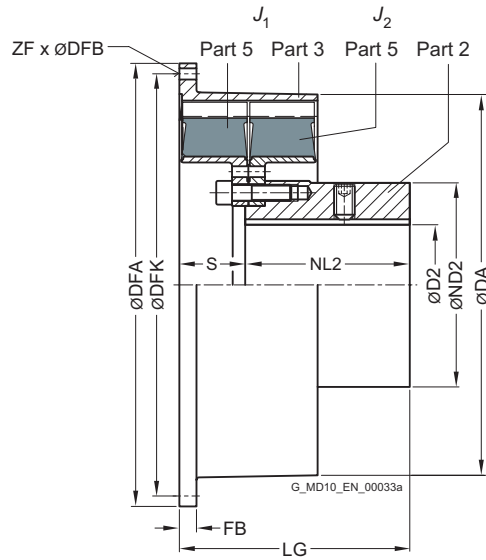

Size	Dimensions in mm							Flange connection dimensions					Mass moment of inertia		Article no. ¹⁾	Weight <i>m</i> kg
	D2 Keyway DIN 6885 max.	DA	ND2	NL2	S	LG	SAE size	DFA	DFK	FB	ZF	DFB	<i>J</i> ₁ kgm ²	<i>J</i> ₂ kgm ²		
520	165	525	250	174	81	255	18	571.5	542.9	25	12	17	1	1.6	2LC0220-7AD0	85
							21	673.1	641.4	18	12	17	1.5			90
560	170	560	316	210	60	270	18	571.5	542.9	35	12	17	1.7	2.8	2LC0220-8AD0	140
							21	673.1	641.4	25	12	17	2.6			150
580	200	585	310	250	100	350	21	673.1	641.4	26	12	17	2	3.8	2LC0221-0AD0	170
							24	733.4	692.2	26	12	21	2.6			175
680	220	682	380	250	17	267	21	673.1	641.4	85	12	17	8.2	7	2LC0221-1AD0	265
							24	733.4	692.2	20	12	21	9.4			275

Configurable variants ¹⁾

- ØD2 Without finished bore
With finished bore
- Rubber version WN
NN
SN
NX

Notes

- The rubber disk element cannot be dismantled until the machines have been moved.
- Weight and mass moments of inertia apply to maximum bore diameters.

Ordering example

- ELPEX-S ESD coupling, size 680, WN rubber element version
- Bore ØD2 = 180H7 mm, with keyway to DIN 6885 and set screw, outer flange to SAE J620d size 24

Article no.: 2LC0221-1AD09-1KA0-Z M2B

¹⁾ To identify complete item numbers specifying the available finish boring options and – if necessary – further order options, please use our configurators on flender.com.

↗ For online configuration on flender.com, click on the item no.

TYPE ESDR

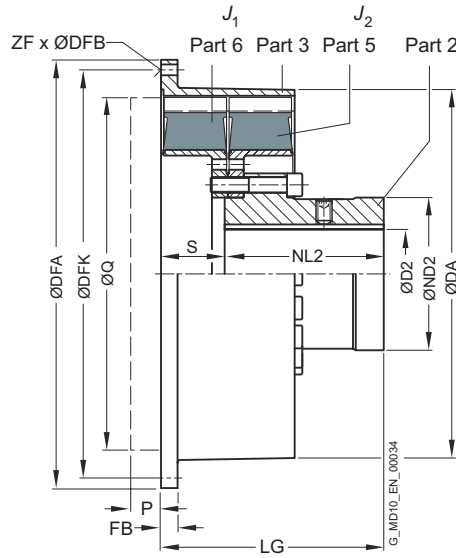

Size	Dimensions in mm								Flange connection dimensions					Mass moment of inertia		Article no. ¹⁾	Weight <i>m</i> kg	
	D2 Keyway DIN 6885 max.	DA	ND2	NL2	S	P	Q	LG	SAE size	DFA	DFK	FB	ZF	DFB	<i>J</i> ₁ kgm ²			<i>J</i> ₂ kgm ²
520	150	525	227	226	83	10	498	309	18	571.5	542.9	25	12	17	1	1.8	2LC0220-7AE0	105
									21	673.1	641.4	18	12	17	1.5		2LC0220-7AE0	110
560	160	560	240	240	100	10	498	340	18	571.5	542.9	35	12	17	1.7	2.5	2LC0220-8AE0	135
									21	673.1	641.4	25	12	17	2.6		2LC0220-8AE0	140
580	160	585	240	250	100	10	560	350	21	673.1	641.4	26	12	17	2	3.2	2LC0221-0AE0	145
									24	733.4	692.2	26	12	21	2.6		2LC0221-0AE0	150
680	200	682	300	250	102	10	584	352	21	673.1	641.4	85	12	17	8.2	6.5	2LC0221-1AE0	260
									24	733.4	692.2	20	12	21	9.4		2LC0221-1AE0	270
770	260	780	390	300	200	10	750	500	-	860.0	820.0	19	32	-	22.3	20	2LC0221-2AE0	540
									-	920.0	880.0	27	32	21	26		2LC0221-2AE0	555
									-	995.0	950.0	27	32	-	31		2LC0221-2AE0	600

Configurable variants¹⁾

- ØD2 Without finished bore
With finished bore
- Rubber version WN
NN
SN
NX

Notes

- Weight and mass moments of inertia apply to maximum bore diameters.
- P, Q = required space for radial dismounting of the rubber disk element.

Ordering example

- ELPEX-S ESDR coupling, size 560, WN rubber element version
- Bore ØD2 = 120H7 mm, with keyway to DIN 6885 and set screw, outer flange to SAE J620d size 21

Article no.: 2LC0220-8AE09-1JA0-Z M1S

¹⁾ To identify complete item numbers specifying the available finish boring options and – if necessary – further order options, please use our configurators on flender.com.

↗ For online configuration on flender.com, click on the item no.

TYPE ESNW

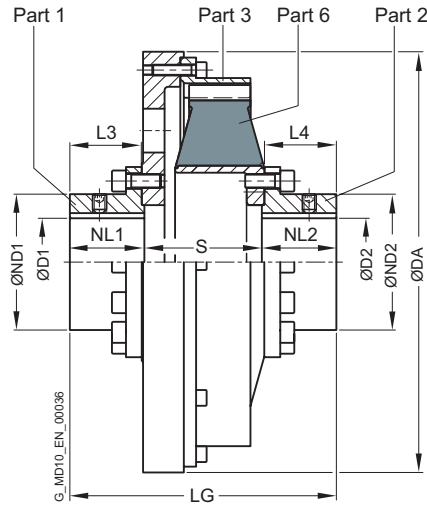

Size	Dimensions in mm								Mass moment of inertia		Article no. ¹⁾	Weight <i>m</i> kg
	D1/D2 Keyway DIN 6885 max.	DA	ND1/ND2	NL1/NL2	L3	L4	S	LG	<i>J</i> ₁ kgm ²	<i>J</i> ₂ kgm ²		
265	50	275	78	65	62	66	68	198	0.11	0.017	2LC0220-1AG	15
290	50	325	78	65	62	68	89	219	0.21	0.028	2LC0220-2AG	22
320	65	365	98	87	84	92	105	279	0.37	0.042	2LC0220-3AG	32
360	85	365	123	88	85	96	123	299	0.45	0.11	2LC0220-4AG	43
420	100	480	155	85	82	94	134	304	1.5	0.3	2LC0220-5AG	75
465	130	480	190	119	116	119	125	363	1.6	0.54	2LC0220-6AG	89
520	150	585	227	162	159	161	123	447	4	0.94	2LC0220-7AG	155
560	150	585	240	180	174	174	132	492	4.1	1.2	2LC0220-8AG	160
580	160	685	240	200	195	198	145	545	5.5	1.6	2LC0221-0AG	185
680	200	685	300	210	205	201	150	570	12	3.6	2LC0221-1AG	315
770	260	870	390	255	250	253	180	690	27.2	12	2LC0221-2AG	500

Configurable variants ¹⁾

- ØD1
Without finished bore
With finished bore

- ØD2
Without finished bore
With finished bore

- Rubber version
WN
NN
SN
NX

Notes

- Weight and mass moments of inertia apply to maximum bore diameters.

Ordering example

- ELPEX-S ESNW coupling, size 520,
WN rubber element version

- Bore ØD1 140H7 mm, keyway to DIN 6885 and set screw

- Bore ØD2 120H7 mm, keyway to DIN 6885 and set screw

Article no.: 2LC0220-7AG99-1AA0-Z L1V+M1S

¹⁾ To identify complete item numbers specifying the available finish boring options and – if necessary – further order options, please use our configurators on flender.com.

↗ For online configuration on flender.com, click on the item no.

TYPE ESDW

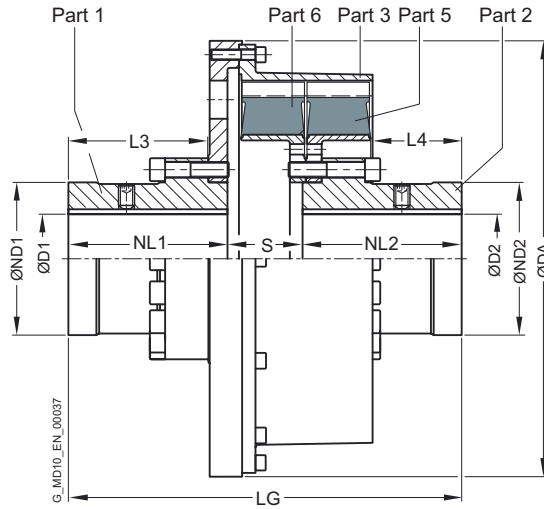

Size	Dimensions in mm								Mass moment of inertia		Article no. ¹⁾	Weight m kg
	D1/D2 Keyway DIN 6885 max.	DA	ND1/ND2	NL1/NL2	L3	L4	S	LG	J ₁ kgm ²	J ₂ kgm ²		
520	150	585	227	226	201	135	100	552	4.7	1.8	2LC0220-7AH	215
560	160	585	240	240	215	133	114	594	5.4	2.5	2LC0220-8AH	250
580	160	685	240	250	220	140	120	620	10.1	3.2	2LC0221-0AH	300
680	200	685	300	250	218	134	125	625	14.5	6.5	2LC0221-1AH	440
770	260	870	390	300	265	238	220	820	40	20	2LC0221-2AH	720

Configurable variants ¹⁾

• ØD1	Without finished bore With finished bore
• ØD2	Without finished bore With finished bore
• Rubber version	WN NN SN NX

Notes

- Weight and mass moments of inertia apply to maximum bore diameters.

Ordering example

- ELPEX-S ESDW coupling, size 520, WN rubber element version
- Bore ØD1 140H7 mm, keyway to DIN 6885 and set screw
- Bore ØD2 120H7 mm, keyway to DIN 6885 and set screw

Article no.: 2LC0220-7AH99-1AA0-Z L1V+M1S

¹⁾ To identify complete item numbers specifying the available finish boring options and – if necessary – further order options, please use our configurators on flender.com.

➤ For online configuration on flender.com, click on the item no.

TYPE EST

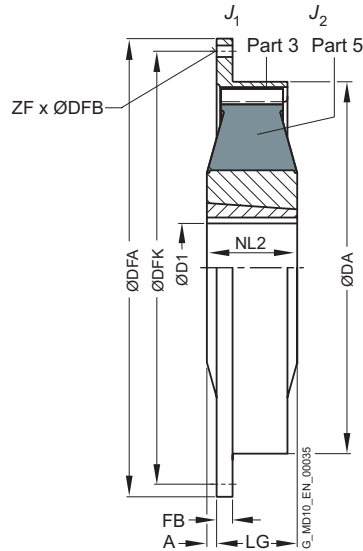

Size	Taper Clamping Bush Size	Dimensions in mm						Flange connection dimensions					Mass moment of inertia		Article no. ¹⁾	Weight <i>m</i> kg		
		D1 Keyway DIN 6885 min.	max.	DA	NL2	A	LG	SAE size	DFA	DFK	FB	ZF	DFB	<i>J</i> ₁ kgm ²			<i>J</i> ₂ kgm ²	
220	2012	14	50	222	32	0	43	52	6.5	215.9	200.0	6	6	8.5	0.008	0.008	2LC0220-0AF0	3.6
								7.5	241.3	222.3	33	8	8.5	0.008	2LC0220-0AF0		3.5	
								8	263.5	244.5	8	6	10.5	0.011	2LC0220-0AF0		3.7	
								10	314.3	295.3	8	8	10.5	0.020	2LC0220-0AF0		4.2	
265	2517	16	60	263	45	3	42	8	263.5	244.5	33	6	0.011	0.019	2LC0220-1AF0	5.9		
								10	314.3	295.3	10	8	10.5		0.017	2LC0220-1AF0	6.2	
								11.5	352.4	333.4	10	8	0.024		2LC0220-1AF0	6.5		
290	2517	16	60	290	64	6	58	10	314.3	295.3	16	8	0.026	0.026	2LC0220-2AF0	8.5		
								11.5	352.4	333.4	16	8	10.5		0.036	2LC0220-2AF0	8.8	
320	3030	35	75	318	76	2	73	11.5	352.4	333.4	16	8	0.062	0.06	2LC0220-3AF0	14		
								14	466.7	438.2	16	8	13		0.18	2LC0220-3AF0	17	
360	3535	35	90	353.5	89	13	76	11.5	352.4	333.4	54	8	0.065	0.13	2LC0220-4AF0	21		
								14	466.7	438.2	15	8	13		0.18	2LC0220-4AF0	24	
								14	466.7	438.2	18	8	13		0.22	2LC0220-5AF0	37	
420	4040	40	100	420	102	10	92	16	517.5	489.0	18	8	0.32	0.33	2LC0220-5AF0	38		
								18	571.5	542.9	18	6	17		0.47	2LC0220-5AF0	41	
								14	466.7	438.2	85	8	13		0.31	2LC0220-6AF0	63	
465	4545	55	110	465	115	28	87	16	517.5	489.0	27	8	0.41	0.76	2LC0220-6AF0	64		
								18	571.5	542.9	18	6	17		0.52	2LC0220-6AF0	68	

Configurable variants ¹⁾

- ØD1 Without finished bore
With finished bore
- Rubber version WN
NN
SN
NX

Notes

- The rubber disk element cannot be dismantled until the machines have been moved.
- Weight and mass moments of inertia apply to maximum bore diameters.

Ordering example

- ELPEX-S EST coupling, size 265, WN rubber element version, with Taper clamping bush size 2517
- Bore ØD2 = 30 mm, outer flange to SAE J620d size 10

Article no.: 2LC0220-1AF99-1DA0-Z M05

¹⁾ To identify complete item numbers specifying the available finish boring options and – if necessary – further order options, please use our configurators on flender.com.

↗ For online configuration on flender.com, click on the item no.

SPARE AND WEAR PARTS

Rubber disk elements

Size	➤ Article No. set of rubber disk elements for a coupling					
	Coupling type EST		ESN	ESNR, ESNW	ESD	ESDR, ESDW
	without Taper clamping bush	with Taper clamping bush				
WN rubber version						
220	2LC0220-0XL10-1AA0	2LC0220-0XL90-1AA0	2LC0220-0XJ00-1AA0			
265	2LC0220-1XL10-1AA0	2LC0220-1XL90-1AA0	2LC0220-1XJ00-1AA0	2LC0220-1XM00-1AA0		
290	2LC0220-2XL10-1AA0	2LC0220-2XL90-1AA0	2LC0220-2XJ00-1AA0	2LC0220-2XM00-1AA0		
320	2LC0220-3XL10-1AA0	2LC0220-3XL90-1AA0	2LC0220-3XJ00-1AA0	2LC0220-3XM00-1AA0		
360	2LC0220-4XL10-1AA0	2LC0220-4XL90-1AA0	2LC0220-4XJ00-1AA0	2LC0220-4XM00-1AA0		
420	2LC0220-5XL10-1AA0	2LC0220-5XL90-1AA0	2LC0220-5XJ00-1AA0	2LC0220-5XM00-1AA0		
465	2LC0220-6XL10-1AA0	2LC0220-6XL90-1AA0	2LC0220-6XJ00-1AA0	2LC0220-6XM00-1AA0		
520			2LC0220-7XJ00-1AA0	2LC0220-7XM00-1AA0	2LC0220-7XK00-1AA0	2LC0220-7XN00-1AA0
560			2LC0220-8XJ00-1AA0	2LC0220-8XM00-1AA0	2LC0220-8XK00-1AA0	2LC0220-8XN00-1AA0
580			2LC0221-0XJ00-1AA0	2LC0221-0XM00-1AA0	2LC0221-0XK00-1AA0	2LC0221-0XN00-1AA0
680			2LC0221-1XJ00-1AA0	2LC0221-1XM00-1AA0	2LC0221-1XK00-1AA0	2LC0221-1XN00-1AA0
770				2LC0221-2XM00-1AA0		2LC0221-2XN00-1AA0
NN rubber version						
220	2LC0220-0XL10-2AA0	2LC0220-0XL90-2AA0	2LC0220-0XJ00-2AA0			
265	2LC0220-1XL10-2AA0	2LC0220-1XL90-2AA0	2LC0220-1XJ00-2AA0	2LC0220-1XM00-2AA0		
290	2LC0220-2XL10-2AA0	2LC0220-2XL90-2AA0	2LC0220-2XJ00-2AA0	2LC0220-2XM00-2AA0		
320	2LC0220-3XL10-2AA0	2LC0220-3XL90-2AA0	2LC0220-3XJ00-2AA0	2LC0220-3XM00-2AA0		
360	2LC0220-4XL10-2AA0	2LC0220-4XL90-2AA0	2LC0220-4XJ00-2AA0	2LC0220-4XM00-2AA0		
420	2LC0220-5XL10-2AA0	2LC0220-5XL90-2AA0	2LC0220-5XJ00-2AA0	2LC0220-5XM00-2AA0		
465	2LC0220-6XL10-2AA0	2LC0220-6XL90-2AA0	2LC0220-6XJ00-2AA0	2LC0220-6XM00-2AA0		
520			2LC0220-7XJ00-2AA0	2LC0220-7XM00-2AA0	2LC0220-7XK00-2AA0	2LC0220-7XN00-2AA0
560			2LC0220-8XJ00-2AA0	2LC0220-8XM00-2AA0	2LC0220-8XK00-2AA0	2LC0220-8XN00-2AA0
580			2LC0221-0XJ00-2AA0	2LC0221-0XM00-2AA0	2LC0221-0XK00-2AA0	2LC0221-0XN00-2AA0
680			2LC0221-1XJ00-2AA0	2LC0221-1XM00-2AA0	2LC0221-1XK00-2AA0	2LC0221-1XN00-2AA0
770				2LC0221-2XM00-2AA0		2LC0221-2XN00-2AA0
SN rubber version						
220	2LC0220-0XL10-3AA0	2LC0220-0XL90-3AA0	2LC0220-0XJ00-3AA0			
265	2LC0220-1XL10-3AA0	2LC0220-1XL90-3AA0	2LC0220-1XJ00-3AA0	2LC0220-1XM00-3AA0		
290	2LC0220-2XL10-3AA0	2LC0220-2XL90-3AA0	2LC0220-2XJ00-3AA0	2LC0220-2XM00-3AA0		
320	2LC0220-3XL10-3AA0	2LC0220-3XL90-3AA0	2LC0220-3XJ00-3AA0	2LC0220-3XM00-3AA0		
360	2LC0220-4XL10-3AA0	2LC0220-4XL90-3AA0	2LC0220-4XJ00-3AA0	2LC0220-4XM00-3AA0		
420	2LC0220-5XL10-3AA0	2LC0220-5XL90-3AA0	2LC0220-5XJ00-3AA0	2LC0220-5XM00-3AA0		
465	2LC0220-6XL10-3AA0	2LC0220-6XL90-3AA0	2LC0220-6XJ00-3AA0	2LC0220-6XM00-3AA0		
520			2LC0220-7XJ00-3AA0	2LC0220-7XM00-3AA0	2LC0220-7XK00-3AA0	2LC0220-7XN00-3AA0
560			2LC0220-8XJ00-3AA0	2LC0220-8XM00-3AA0	2LC0220-8XK00-3AA0	2LC0220-8XN00-3AA0
580			2LC0221-0XJ00-3AA0	2LC0221-0XM00-3AA0	2LC0221-0XK00-3AA0	2LC0221-0XN00-3AA0
680			2LC0221-1XJ00-3AA0	2LC0221-1XM00-3AA0	2LC0221-1XK00-3AA0	2LC0221-1XN00-3AA0
770				2LC0221-2XM00-3AA0		2LC0221-2XN00-3AA0
NX rubber version						
220	2LC0220-0XL10-4AA0	2LC0220-0XL90-4AA0	2LC0220-0XJ00-4AA0			
265	2LC0220-1XL10-4AA0	2LC0220-1XL90-4AA0	2LC0220-1XJ00-4AA0	2LC0220-1XM00-4AA0		
290	2LC0220-2XL10-4AA0	2LC0220-2XL90-4AA0	2LC0220-2XJ00-4AA0	2LC0220-2XM00-4AA0		
320	2LC0220-3XL10-4AA0	2LC0220-3XL90-4AA0	2LC0220-3XJ00-4AA0	2LC0220-3XM00-4AA0		
360	2LC0220-4XL10-4AA0	2LC0220-4XL90-4AA0	2LC0220-4XJ00-4AA0	2LC0220-4XM00-4AA0		
420	2LC0220-5XL10-4AA0	2LC0220-5XL90-4AA0	2LC0220-5XJ00-4AA0	2LC0220-5XM00-4AA0		
465	2LC0220-6XL10-4AA0	2LC0220-6XL90-4AA0	2LC0220-6XJ00-4AA0	2LC0220-6XM00-4AA0		
520			2LC0220-7XJ00-4AA0	2LC0220-7XM00-4AA0	2LC0220-7XK00-4AA0	2LC0220-7XN00-4AA0
560			2LC0220-8XJ00-4AA0	2LC0220-8XM00-4AA0	2LC0220-8XK00-4AA0	2LC0220-8XN00-4AA0
580			2LC0221-0XJ00-4AA0	2LC0221-0XM00-4AA0	2LC0221-0XK00-4AA0	2LC0221-0XN00-4AA0
680			2LC0221-1XJ00-4AA0	2LC0221-1XM00-4AA0	2LC0221-1XK00-4AA0	2LC0221-1XN00-4AA0
770				2LC0221-2XM00-4AA0		2LC0221-2XN00-4AA0

Notes

- The ELPEX-S coupling rubber disk elements are wear parts. The service life depends on the operating conditions.

HIGHLY FLEXIBLE COUPLINGS – ELPEX SERIES



General	12/3
Benefits	12/3
Application	12/3
Design and configurations	12/4
Configuration	12/5
Technical specifications	12/7
<hr/>	
Type ENG	12/8
<hr/>	
Type ENGS – with fail-safe device	12/10
<hr/>	
Types EFG	12/12
<hr/>	
Types EFGS – with fail-safe device	12/14
<hr/>	
Spare and wear parts	12/16
<hr/>	



ELPEX
FLENDER

GENERAL



ELPEX couplings are highly torsionally flexible and free of torsional backlash. Because of their low torsional stiffness and damping capacity, ELPEX couplings are especially suitable for coupling machines with a very non uniform torque pattern. ELPEX couplings are also suitable for connecting machines with high shaft misalignment. Standard ELPEX coupling types are designed as shaft-shaft connections or flange-shaft connections. Application-related types can be implemented on request.

Benefits

The ELPEX coupling is suitable for horizontal and vertical mounting positions or mounting at any required angle. The coupling parts can be arranged as required on the shafts to be connected.

The split flexible rings can be changed without having to move the coupled machines.

The flexible rings are mounted without backlash and give the coupling progressive torsional stiffness, i.e. torsional stiffness increases in proportion to coupling load.

The ELPEX coupling is especially suitable for reversing operation or operation with changing directions of load.

The coupling is delivered preassembled. The flexible rings are completely assembled. On the type ENG, the coupling halves have to be bolted together after the hub has been mounted. On the type EFG, after mounting the coupling hub, only the outer flange has to be connected to the machine.

Outer flanges with different connection dimensions are available for the type EFG.

If the flexible rings are irreparably damaged or worn, the metal parts can rotate freely against one another, they are not in contact with one another.

Application

The ELPEX coupling is available in 9 sizes with a nominal torque of between 1600 Nm and 90000 Nm. The coupling is suitable for ambient temperatures of between -40 °C and +80 °C.

The ELPEX coupling is frequently used for high-quality drives which have to guarantee very long service life in harsh operating conditions.

Examples of applications are mill drives in the cement industry, marine main and secondary drives or drives on large excavators powered by an electric motor or diesel engine.

GENERAL

Design and configurations

The ELPEX coupling's transmission characteristic is determined essentially by the flexible rings. The flexible rings are manufactured from a natural rubber mixture with a multiply fabric lining. The flexible rings are split so that they can be changed without having to move the coupled machines.

The flexible rings are fastened to the hub with a clamping ring and to the outer flange with a clamping ring, using pins and bolts.

On the EFG type, the outer flange is designed with connection dimensions for connection to e.g. a diesel engine flywheel. On ENG types, the outer flange is fitted to a second hub part, which then enables the shaft-shaft connection.

Materials

	Type	Cast iron	Steel
Hub part 1		Grey cast iron EN-GJL-250	Steel
Hub part 2		Steel	Steel
Retaining ring, outer ENG, ENGS		Grey cast iron EN-GJL-250	Steel
Outer flange EFG, EFGS		Grey cast iron EN-GJL-250	Steel

Flexible ring materials

Material/Description	Hardness	Marking	Ambient temperature
Natural rubber	70 ShoreA	Size - 2	-40 ... +80 °C

ELPEX coupling types

Type	Description
ENG	Coupling as shaft-shaft connection
EFG	Coupling as flange-shaft connection
ENGS	as ENG with fail-safe device
EFGS	as EFG with fail-safe device

Further application-specific coupling types are available. Dimension sheets for and information on these are available on request.

The following versions have already been implemented a number of times:

- ELPEX coupling with brake drum, brake disk or flywheel mass
- ELPEX coupling with axial backlash limiter
- ELPEX coupling with adapter
- ELPEX coupling in combination with a safety slip clutch
- ELPEX coupling for engaging/disengaging during stand-still ELPEX coupling as part of a coupling combination

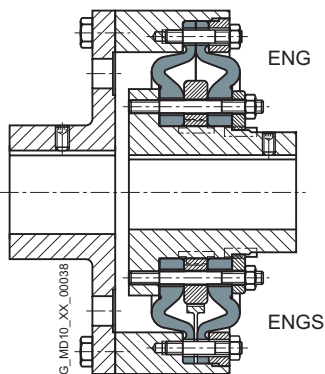

Types ENG/ENGS

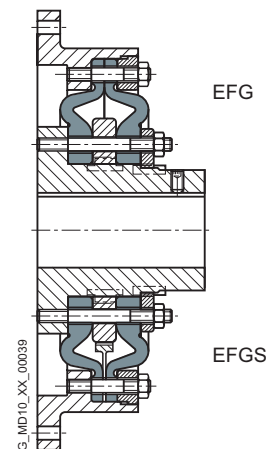

Types EFG/EFGS

Fail-safe device of ELPEX coupling

Types ENGS and EFGS are provided with a fail-safe device. In normal operation the torsion angle of the flexible rings is smaller than the gap between the cams. In normal operation there is no metal-metal contact. If the flexible rings fail, cams transmit the torque from the inner part and outer part. These enable the coupling to be used in emergency mode for a short time. This option is frequently required e.g. in the case of marine drives.

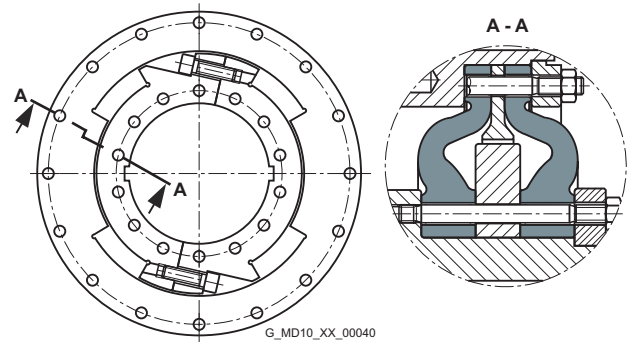

Fail-safe device

Configuration

Coupling selection

The ELPEX coupling is especially suitable for rough operating environments. An application factor lower than that in **Chapter introduction** is therefore sufficient for all applications.

In the case of machines which excite torsional vibration, Flender urgently recommends carrying out a torsional vibration calculation or measuring the coupling load occurring in the drive.

Coupling load in continuous operation

The operating principles of the driving and driven machines are divided into categories and the application factor FB derived from these in accordance with DIN 3990-1.

Examples of torque characteristic in driven machines:

- uniform with moderate shock loads: Generators, fans, blowers
- non uniform: Reciprocating compressors, mixers, conveyor systems
- very rough: crushers, excavators, presses, mills

Application factor FB	Torque characteristic of the driven machine		
	uniform with moderate shock loads	non uniform	very rough
Electric motors, hydraulic motors, gas and water turbines	1.0	1.3	1.4
Internal-combustion engines	1.3	1.4	1.6

Temperature factor FT		Temperature T_a on the coupling				
Coupling	Elastomer material	-40 up to -30 °C	-30 up to +50 °C	up to 60 °C	up to 70 °C	up to 80 °C
ELPEX	NR	1.1	1.0	1.25	1.40	1.60

NR = Natural rubber mixture

Coupling size $T_{KN} \geq T_N \cdot FB \cdot FT$

GENERAL

Coupling load under maximum and overload conditions

The maximum torque is the highest load acting on the coupling in normal operation.

Maximum torques at a frequency of up to 25 times an hour are permitted and must be lower than the maximum coupling torque. Examples of maximum torque conditions are: Starting operations, stopping operations or usual operating conditions with maximum load.

$$T_{K_{\max}} \geq T_{\text{Max}} \cdot FT$$

Overload torques are maximum loads which occur only in combination with special, infrequent operating conditions. Examples of overload torque conditions are: Motor short circuit, emergency stop or blocking because of component breakage. Overload torques at a frequency of once a month are permitted and must be lower than the maximum overload torque of the coupling. The overload condition may last only a short while, i.e. fractions of a second.

$$T_{K_{OL}} \geq T_{OL} \cdot FT$$

Coupling load due to dynamic torque load

Applying the frequency factor FF, the dynamic torque load must be lower than the coupling fatigue torque.

Dynamic torque load

$$T_{KW} \geq T_W \cdot FT \cdot FF$$

Frequency of the dynamic torque load

$$f_{\text{err}} \leq 10 \text{ Hz frequency factor } FF = 1.0$$

Frequency of the dynamic torque load

$$f_{\text{err}} > 10 \text{ Hz frequency factor } FF = \sqrt{(f_{\text{err}}/10 \text{ Hz})}$$

Checking the maximum speed

For all load situations $n_{K_{\max}} \geq n_{\text{max}}$

Checking permitted shaft misalignment and restorative forces

For all load situations, the actual shaft misalignment must be less than the permitted shaft misalignment.

Checking bore diameter, mounting geometry and coupling design

The check must be made on the basis of the dimension tables. On request, couplings with adapted geometry can be provided.

Checking shaft-hub connection

For any information on this, please refer to **Page E/20**.

Checking low temperature and chemically aggressive environment

The permitted coupling temperature is specified in the Temperature Factor FT table. In the case of chemically aggressive environments, please consult the manufacturer.

Technical specifications

Power ratings of the ELPEX series										
Size	Rated torque T_{KN} Nm	Maximum torque T_{Kmax} Nm	Overload torque T_{KOL} Nm	Fatigue torque T_{KW} Nm	Dynamic torsional stiffness for 100 % load C_{Tdyn} kNm/rad	Stiffness		Permitted shaft misalignment at speed $n = 1500$ rpm		
						Axial C_a N/mm	Radial C_r mm	Axial ΔK_a mm	Radial ΔK_r mm	Angle ΔK_w °
270	1600	4800	6400	640	22	660	770	2.2	2.2	0.2
320	2800	8400	11200	1120	38	780	910	2.6	2.6	0.2
375	4500	13500	18000	1800	63	970	1130	3	3	0.2
430	7100	21300	28400	2840	97	1160	1350	3.4	3.4	0.2
500	11200	33600	44800	4480	155	1410	1630	3.8	3.8	0.2
590	18000	54000	72000	7200	240	1710	1990	4.2	4.2	0.2
690	28000	84000	112000	11200	365	2060	2390	4.6	4.6	0.2
840	45000	135000	180000	18000	685	2570	2990	5	5	0.2
970	90000	270000	360000	36000	1100	3020	3510	5.5	5.5	0.2

Torsional stiffness and damping

The dynamic torsional stiffness is load-dependent and increases in proportion to capacity utilization. The values specified in the selection table apply to a capacity utilization of 100 %. The following table shows the correction factors for different rated loads.

$$C_{Tdyn} = C_{Tdyn 100\%} \cdot FK_C$$

	Load T_N / T_{KN}						
	20%	50%	60%	70%	80%	100%	200%
Correction factor FK _C	0.3	0.56	0.65	0.74	0.82	1	1.9

The damping coefficient is $\Psi = 1.1$

Torsional stiffness also depends on the ambient temperature and the frequency and amplitude of the torsional vibration excitation. More precise torsional stiffness and damping parameters on request.

With flexible couplings the manufacturing process of the rubber elements and their aging primarily influence the stiffness value C_{Tdyn} . For this reason calculation must be made with a tolerance for the dynamic stiffness of $\pm 20\%$. The specified damping coefficient Ψ is a minimum value with the result that the damping performance of the coupling corresponds at least to the specified value.

Permitted shaft misalignment

The permitted shaft misalignment depends on the operating speed. As the speed increases, lower shaft misalignment values are permitted. The correction factors for different speeds are specified in the following table. The maximum speed for the respective coupling size must be noted!

$$\Delta K_{perm} = \Delta K_{1500} \cdot FK_V$$

	Speed in rpm			
	500	1000	1500	3000
Correction factor FK _V	1.6	1.25	1.0	0.7

TYPE ENG

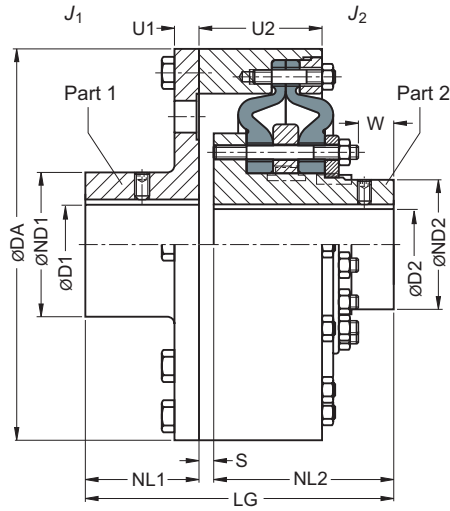

Sizes 270 ... 430

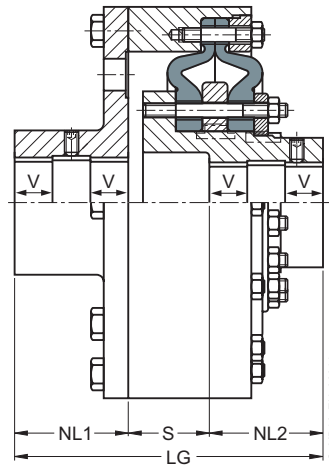

Sizes 500 ... 970

Size	Rated torque T_{KN} Nm	Maximum speed		Dimensions in mm								Mass moment of inertia		Article no. ¹⁾		Weight m kg							
		n_{Kmax} rpm	n_{Kmax} rpm	Keyway DIN 6885				J_1 kgm ²	J_2 kgm ²	Type													
		Cast iron	Steel	D1 min.	D1 max.	D2 min.	D2 max.			DA	ND1	ND2	NL1	NL2	S	U1	U2	W	LG	Cast iron	Steel		
270	1600	3000	4250	45	80	45	70	270	128	94	80	155	10	14	86	42	245	0.21	0.037	2LC0200-3AF	2LC0200-3AL	29	
320	2800	2500	3600	55	100	55	85	320	160	115	100	180	6	16	97.5	48	286	0.49	0.082	2LC0200-4AF	2LC0200-4AL	50	
375	4500	2100	3100	65	115	65	105	375	184	143	120	205	10	18	111.8	62	335	1.0	0.21	2LC0200-5AF	2LC0200-5AL	80	
430	7100	1900	2650	75	130	75	120	430	208	165	140	235	8	22	126	68	383	2.0	0.37	2LC0200-6AF	2LC0200-6AL	113	
500	11200	1600	2300	90	150	90	150	500	240	202	160	160	112	25	139.7	80	432	3.9	0.85	2LC0200-7AF	2LC0200-7AL	174	
590	18000	1360	2000	100	140	100	170	590	224	230	190	190	130	28	162.7	95	510	8.2	1.7	2LC0200-8AF	2LC0200-8AL	254	
				140	180		224		16.3									350					
690	28000	1200	1650	110	140	110	200	690	288	278	220	220	140	32	175.6	102	580	16.8	3.7	2LC0201-0AF	2LC0201-0AL	370	
				180	210		336		16.9									385					
840	45000	1000	1350	140	180	140	240	840	288	340	280	280	125	42	231	105	685	49	11	2LC0201-1AF	2LC0201-1AL	700	
				180	220		352		50									725					
970	90000	850	1180	160	200	160	280	970	320	384	390	350	350	167	70	290	137	867	104	26	2LC0201-2AF	2LC0201-2AL	1265
				200	240		448		110										1310				
				240	280				512									115				1410	

Configurable variants ¹⁾

- ØD1 Without finished bore
With finished bore
- ØD2 Without finished bore
With finished bore

¹⁾ To identify complete item numbers specifying the available finish boring options and – if necessary – further order options, please use our configurators on flender.com.

↗ For online configuration on flender.com, click on the item no.

Notes

- The hub diameter of the component part is assigned according to the diameter of the finished bore. Where bore diameters overlap, the component with the smaller hub diameter is always selected.
- Weights and mass moments of inertia apply to cast iron version with maximum bore.
- From size 500, the bores D1 and D2 are each provided with a recess of $D = +1$ mm halfway along the hub. $V \approx 1/3$ NL.

Ordering example

- ELPEX ENG coupling, size 690, cast iron version
- Bore $\varnothing D1 = 180H7$ mm with keyway to DIN 6885 and set screw, the hub diameter $ND1 = 288$ mm is thus assigned
- Bore $\varnothing D2 = 200H7$ mm with keyway to DIN 6885 and set screw, the hub diameter $ND2 = 278$ mm is thus assigned

Article no.: **2LC0201-0AF99-0AA0-Z L2B+M2D**

¹⁾ To identify complete item numbers specifying the available finish boring options and – if necessary – further order options, please use our configurators on [flender.com](https://www.flender.com).

➤ For online configuration on [flender.com](https://www.flender.com), click on the item no.

TYPE ENGS

with fail-safe device

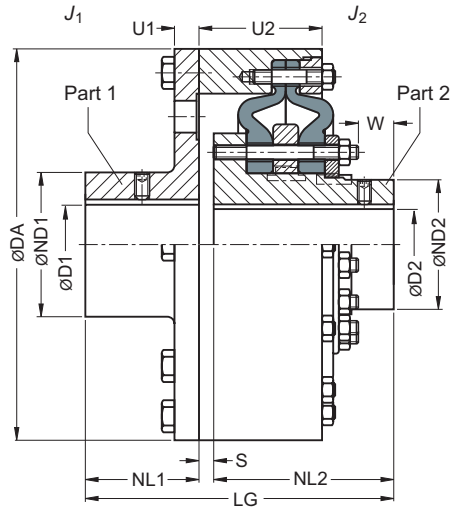

Sizes 270 ... 430

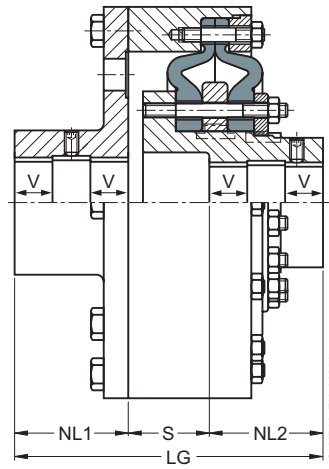

Sizes 500 ... 970

Size	Rated torque T_{KN} Nm	Maximum speed		Dimensions in mm																Mass moment of inertia		Article no. ¹⁾		Weight m kg
		n_{Kmax} rpm	n_{Kmax} rpm	Keyway DIN 6885				DA	ND1	ND2	NL1	NL2	S	U1	U2	W	LG	J_1 kgm ²	J_2 kgm ²	Cast iron	Steel			
270	1600	3000	4250	45	80	45	70	270	128	94	80	155	10	14	86	42	245	0.21	0.037	2LC0200-3AG	2LC0200-3AM	29		
320	2800	2500	3600	55	100	55	85	320	160	115	100	180	6	16	97.5	48	286	0.49	0.082	2LC0200-4AG	2LC0200-4AM	50		
375	4500	2100	3100	65	115	65	105	375	184	143	120	205	10	18	111.8	62	335	1.0	0.21	2LC0200-5AG	2LC0200-5AM	80		
430	7100	1900	2650	75	130	75	120	430	208	165	140	235	8	22	126	68	383	2.0	0.37	2LC0200-6AG	2LC0200-6AM	113		
500	11200	1600	2300	90	150	90	150	500	240	202	160	160	112	25	139.7	80	432	3.9	0.85	2LC0200-7AG	2LC0200-7AM	174		
590	18000	1360	2000	100	140	100	170	590	224	230	190	190	130	28	162.7	95	510	8.2	1.7	2LC0200-8AG	2LC0200-8AM	254		
				140	180		224		16.3									350						
690	28000	1200	1650	110	140	110	200	690	288	278	220	220	140	32	175.6	102	580	16.8	3.7	2LC0201-0AG	2LC0201-0AM	370		
				180	210		336		16.9									385						
840	45000	1000	1350	140	180	140	240	840	288	340	280	280	125	42	231	105	685	49	11	2LC0201-1AG	2LC0201-1AM	700		
				180	220		352		50									725						
970	90000	850	1180	160	200	160	280	970	320	384	390	350	350	167	70	290	137	867	104	26	2LC0201-2AG	2LC0201-2AM	1265	
				200	240		448		106										1310					
				240	280				512									110				1350		
				280	320													115				1410		

Configurable variants ¹⁾

- ØD1 Without finished bore
With finished bore
- ØD2 Without finished bore
With finished bore

¹⁾ To identify complete item numbers specifying the available finish boring options and – if necessary – further order options, please use our configurators on flender.com.

↗ For online configuration on flender.com, click on the item no.

Notes

- The hub diameter of the component part is assigned according to the diameter of the finished bore. Where bore diameters overlap, the component with the smaller hub diameter is always selected.
- Weights and mass moments of inertia apply to cast iron version with maximum bore.
- From size 500, the bores D1 and D2 are each provided with a recess of $D = +1$ mm halfway along the hub. $V \approx 1/3$ NL.

Ordering example

- ELPEX ENGS coupling, size 690, cast iron version
- Bore $\varnothing D1 = 180H7$ mm with keyway to DIN 6885 and set screw, the hub diameter $ND1 = 288$ mm is thus assigned
- Bore $\varnothing D2 = 200H7$ mm with keyway to DIN 6885 and set screw, the hub diameter $ND2 = 278$ mm is thus assigned

Article no.: **2LC0201-0AG99-0AA0-Z L2B+M2D**

¹⁾ To identify complete item numbers specifying the available finish boring options and – if necessary – further order options, please use our configurators on [flender.com](https://www.flender.com).

➤ For online configuration on [flender.com](https://www.flender.com), click on the item no.

TYPES EFG

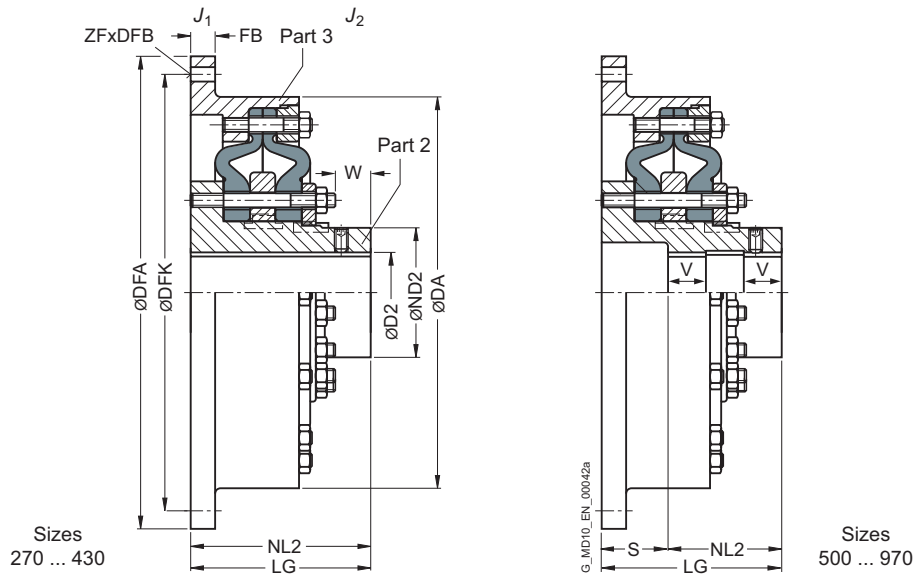

12

Size	Rated torque T_{KN} Nm	Maximum speed		Dimensions in mm										Mass moment of inertia		Article no. ¹⁾		Weight m kg			
		Type Cast iron	Steel	D2 Keyway DIN 6885 min. max.	DA	ND2	NL2	S	W	LG	Flange connection dimensions ²⁾					J_1 kgm ²	J_2 kgm ²		Type	Cast iron	Steel
											DFA	DFK	FB	ZF	DFB						
270	1600	3000	4250	45	70	270	94	155	-	42	155	466.7 ₉₇ ²⁾	438.2 ²⁾	12	8	13	0.47	0.037	2LC0200-3AB2	2LC0200-3AJ2	27
												325 ₆	300		8	14	0.16		2LC0200-3AB1	2LC0200-3AJ1	19
320	2800	2500	3600	55	85	320	115	180	-	48	180	517.5 ₉₇ ²⁾	489 ²⁾	14	8	13	0.87	0.082	2LC0200-4AB2	2LC0200-4AJ2	42
												392 ₆	360		8	18	0.39		2LC0200-4AB1	2LC0200-4AJ1	33.5
375	4500	2100	3100	65	105	375	143	205	-	62	205	571.5 ₉₇ ²⁾	542.9 ²⁾	16	6	17	1.5	0.21	2LC0200-5AB2	2LC0200-5AJ2	65
												448 ₆	415		8	18	0.78		2LC0200-5AB1	2LC0200-5AJ1	53
430	7100	1900	2650	75	120	430	165	235	-	68	235	673.1 ₉₇ ²⁾	641.4 ²⁾	20	12	17	3.4	0.37	2LC0200-6AB2	2LC0200-6AJ2	100
												515 ₆	475		8	22	1.5		2LC0200-6AB1	2LC0200-6AJ1	78
500	11200	1600	2300	90	150	500	202	160	100	80	260	673.1 ₉₇ ²⁾	641.4 ²⁾	20	12	17	4.0	0.85	2LC0200-7AB2	2LC0200-7AJ2	150
												585 ₆	545		10	22	2.7		2LC0200-7AB1	2LC0200-7AJ1	140

Configurable variants ¹⁾

- ØD2 Without finished bore
With finished bore

¹⁾ To identify complete item numbers specifying the available finish boring options and – if necessary – further order options, please use our configurators on flender.com.

²⁾ The upper line for the flange connection dimensions complies with standard SAE J620d or DIN 6288.

↗ For online configuration on flender.com, click on the item no.

Size	Rated torque T_{KN} Nm	Maximum speed		Dimensions in mm										Mass moment of inertia		Article no. ¹⁾		Weight m kg			
		Type Cast iron n_{Kmax} rpm	Steel n_{Kmax} rpm	D2 Keyway DIN 6885 min. max.	DA	ND2	NL2	S	W	LG	Flange connection dimensions ²⁾					J_1 kgm ²	J_2 kgm ²		Type Cast iron	Steel	
											DFA	DFK	FB	ZF	DFB						
590	18000	1350	2000	100	170	590	230	190	120	95	310	$\frac{733.4_{g7}^{21}}{692_{j6}}$	$\frac{692.2^{21}}{645}$	24	12	21	7.0	1.7	2LC0200-8AB2	2LC0200-8AJ2	200
															10	26	6.0		2LC0200-8AB1	2LC0200-8AJ1	190
690	28000	1200	1650	110	200	690	278	220	130	102	350	$\frac{890_{g7}^{21}}{800_{j6}}$	$\frac{850^{21}}{750}$	24	32	17	15	3.7	2LC0201-0AB2	2LC0201-0AJ2	270
															12	26	11		2LC0201-0AB1	2LC0201-0AJ1	250
840	45000	1000	1350	140	240	840	340	280	115	105	395	$\frac{1105_{g7}^{21}}{960_{j6}}$	$\frac{1060^{21}}{908}$	30	32	21	46	11	2LC0201-1AB2	2LC0201-1AJ2	530
															16	30	32		2LC0201-1AB1	2LC0201-1AJ1	470
970	90000	850	1180	160	280	970	390	350	155	137	505	$\frac{1385_{g7}^{21}}{1112_{j6}}$	$\frac{1320^{21}}{1051}$	35	24	31	130	26	2LC0201-2AB2	2LC0201-2AJ2	1050
															16	35	76		2LC0201-2AB1	2LC0201-2AJ1	920

Configurable variants ¹⁾

- ØD2 Without finished bore
With finished bore

Notes

- The hub diameter of the component part is assigned according to the diameter of the finished bore. Where bore diameters overlap, the component with the smaller hub diameter is always selected.
- Weights and mass moments of inertia apply to cast iron version with maximum bore.
- From size 500, the bores D1 and D2 are each provided with a recess of D = +1 mm halfway along the hub. $V \approx 1/3 NL$.
- Notice: The application factor FB in the coupling selection Page 12/5 section must be noted.

Ordering example

- ELPEX EFG coupling, size 430, steel version
- Bore ØD1 = 100H7 mm with keyway to DIN 6885 and set screw, flange to SAE J620d size 21 with DFA = 673.5g7 mm
- Coupling balanced G6.3 in accordance with the half parallel key standard.

Article no.: 2LC0200-6AJ29-0AA0-ZM1N+W02

¹⁾ To identify complete item numbers specifying the available finish boring options and – if necessary – further order options, please use our configurators on flender.com.
²⁾ The upper line for the flange connection dimensions complies with standard SAE J620d or DIN 6288.
 ↗ For online configuration on flender.com, click on the item no.

TYPES EFGS

with fail-safe device

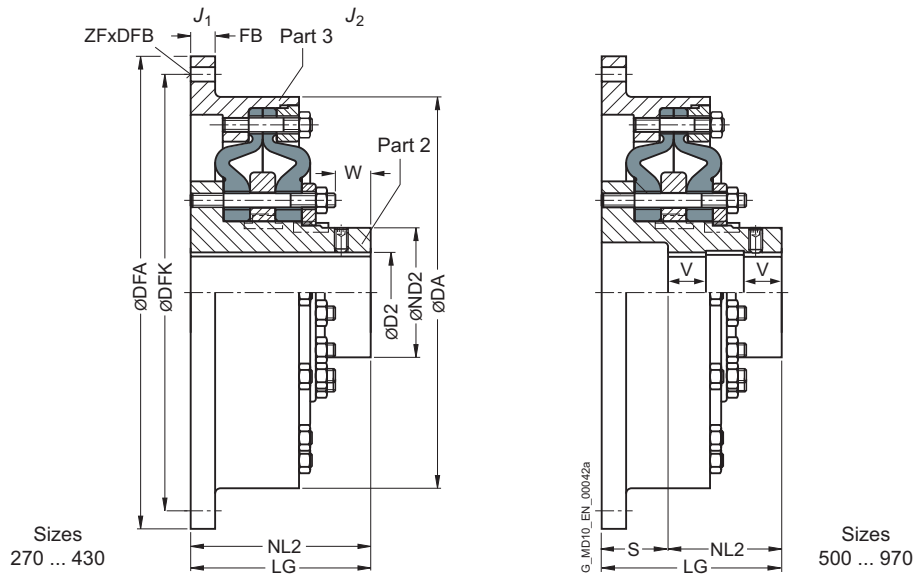

12

Size	Rated torque T_{KN} Nm	Maximum speed		Dimensions in mm										Mass moment of inertia		Article no. ¹⁾		Weight m kg			
		Type Cast iron	Steel	D2 Keyway DIN 6885 min. max.	DA	ND2	NL2	S	W	LG	Flange connection dimensions ²⁾					J_1 kgm ²	J_2 kgm ²		Type	Cast iron	Steel
											DFA	DFK	FB	ZF	DFB						
270	1600	3000	4250	45	70	270	94	155	-	42	155	466.7 ₉₇ ²⁾	438.2 ²⁾	12	8	13	0.47	0.037	2LC0200-3AC2	2LC0200-3AK2	27
												325 ₆	300	8	14	0.16	2LC0200-3AC1		2LC0200-3AK1	19	
320	2800	2500	3600	55	85	320	115	180	-	48	180	517.5 ₉₇ ²⁾	489 ²⁾	14	8	13	0.87	0.082	2LC0200-4AC2	2LC0200-4AK2	42
												392 ₆	360	8	18	0.39	2LC0200-4AC1		2LC0200-4AK1	33.5	
375	4500	2100	3100	65	105	375	143	205	-	62	205	571.5 ₉₇ ²⁾	542.9 ²⁾	16	6	17	1.5	0.21	2LC0200-5AC2	2LC0200-5AK2	65
												448 ₆	415	8	18	0.78	2LC0200-5AC1		2LC0200-5AK1	53	
430	7100	1900	2650	75	120	430	165	235	-	68	235	673.1 ₉₇ ²⁾	641.4 ²⁾	20	12	17	3.4	0.37	2LC0200-6AC2	2LC0200-6AK2	100
												515 ₆	475	8	22	1.5	2LC0200-6AC1		2LC0200-6AK1	78	
500	11200	1600	2300	90	150	500	202	160	100	80	260	673.1 ₉₇ ²⁾	641.4 ²⁾	20	12	17	4.0	0.85	2LC0200-7AC2	2LC0200-7AK2	150
												585 ₆	545	10	22	2.7	2LC0200-7AC1		2LC0200-7AK1	140	

Configurable variants ¹⁾

- ØD2 Without finished bore
With finished bore

¹⁾ To identify complete item numbers specifying the available finish boring options and – if necessary – further order options, please use our configurators on flender.com.

²⁾ The upper line for the flange connection dimensions complies with standard SAE J620d or DIN 6288.

↗ For online configuration on flender.com, click on the item no.

Size	Rated torque T_{KN} Nm	Maximum speed		Dimensions in mm										Mass moment of inertia		Article no. ¹⁾		Weight m kg			
		Cast iron n_{Kmax} rpm	Steel n_{Kmax} rpm	D2 Keyway DIN 6885 min. max.	DA	ND2	NL2	S	W	LG	Flange connection dimensions ²⁾					J_1 kgm ²	J_2 kgm ²		Cast iron	Steel	
											DFA	DFK	FB	ZF	DFB						
590	18000	1350	2000	100	170	590	230	190	120	95	310	733.4 _{g7} ²⁾	692.2 ²⁾	24	12	21	7.0	1.7	2LC0200-8AC2	2LC0200-8AK2	200
												692 _{g6}	645		10	26	6.0		2LC0200-8AC1	2LC0200-8AK1	190
690	28000	1200	1650	110	200	690	278	220	130	102	350	890 _{g7} ²⁾	850 ²⁾	24	32	17	15	3.7	2LC0201-0AC2	2LC0201-0AK2	270
												800 _{g6}	750		12	26	11		2LC0201-0AC1	2LC0201-0AK1	250
840	45000	1000	1350	140	240	840	340	280	115	105	395	1105 _{g7} ²⁾	1060 ²⁾	30	32	21	46	11	2LC0201-1AC2	2LC0201-1AK2	530
												960 _{g6}	908		16	30	32		2LC0201-1AC1	2LC0201-1AK1	470
970	90000	850	1180	160	280	970	390	350	155	137	505	1385 _{g7} ²⁾	1320 ²⁾	35	24	31	130	26	2LC0201-2AC2	2LC0201-2AK2	1050
												1112 _{g6}	1051		16	35	76		2LC0201-2AC1	2LC0201-2AK1	920

Configurable variants ¹⁾

- ØD2 Without finished bore
With finished bore

Notes

- The hub diameter of the component part is assigned according to the diameter of the finished bore. Where bore diameters overlap, the component with the smaller hub diameter is always selected.
- Weights and mass moments of inertia apply to cast iron version with maximum bore.
- From size 500, the bores D1 and D2 are each provided with a recess of D = +1 mm halfway along the hub. $V \approx 1/3 NL$.
- Notice: The application factor FB in the coupling selection Page 12/5 section must be noted.

Ordering example

- ELPEX EFGS coupling, size 430, steel version
- Bore ØD1 = 100H7 mm with keyway to DIN 6885 and set screw, flange to SAE J620d size 21 with DFA = 673.5g7 mm
- Coupling balanced G6.3 in accordance with the half parallel key standard.

Article no.: 2LC0200-6AK29-0AA0-Z M1N+W02

¹⁾ To identify complete item numbers specifying the available finish boring options and – if necessary – further order options, please use our configurators on flender.com.
²⁾ The upper line for the flange connection dimensions complies with standard SAE J620d or DIN 6288.
 ↗ For online configuration on flender.com, click on the item no.

SPARE AND WEAR PARTS

Flexible rings

Size	➤ Article no. set of flexible rings for a coupling	Weight kg
270	2LC0200-3XV00-0AA0	1.6
320	2LC0200-4XV00-0AA0	2.6
375	2LC0200-5XV00-0AA0	4.4
430	2LC0200-6XV00-0AA0	6.8
500	2LC0200-7XV00-0AA0	9.4
590	2LC0200-8XV00-0AA0	18
690	2LC0201-0XV00-0AA0	36
840	2LC0201-1XV00-0AA0	68
970	2LC0201-2XV00-0AA0	120

Note

- The flexible rings are wear parts. The service life depends on the operating conditions.

Flexible ring screw connection

Size	➤ Article no. set of pins and bolts	
	Type EFG, ENG	EFGS, ENGS
270	2LC0200-3XU00-0AA0	2LC0200-3XW00-0AA0
320	2LC0200-4XU00-0AA0	2LC0200-4XW00-0AA0
375	2LC0200-5XU00-0AA0	2LC0200-5XW00-0AA0
430	2LC0200-6XU00-0AA0	2LC0200-6XW00-0AA0
500	2LC0200-7XU00-0AA0	2LC0200-7XW00-0AA0
590	2LC0200-8XU00-0AA0	2LC0200-8XW00-0AA0
690	2LC0201-0XU00-0AA0	2LC0201-0XW00-0AA0
840	2LC0201-1XU00-0AA0	2LC0201-1XW00-0AA0
970	2LC0201-2XU00-0AA0	2LC0201-2XW00-0AA0

APPENDIX

Fits	A/2
Fitting recommendations	A/2
Deviation table to DIN ISO 286	A/2
Cylindrical shaft ends, extract from DIN 748 Part 1 (long)	A/3
Central holes according to DIN 332 Part 2	A/3
Parallel key connections to DIN 6885-1	A/4
Related catalogs	A/6
Suitable gear solutions	A/8
The perfect coupling	A/10
Individual solutions	A/12
Flender Services	A/16

FITS

Fitting recommendations

For many applications, the fit assignment m6/H7 is especially suitable.

Description	Application	Shaft tolerance	Bore tolerance
Facile sliding fit	For steel or aluminum hubs Preferred for SIPEX and BIPEX-S coupling series	g6	H7
		h7	H7
		k6	F7
		m6	F7
Sliding fit with parallel key connection not suitable for reversing operation	For steel and cast hubs	j6	H7
		h6	J7
Press fit with parallel key connection not suitable for reversing operation	For steel and cast hubs	h6	K7
		k6	H7
Interference fit with parallel key connection suitable for reversing operation	For steel and cast hubs Only for steel hubs Preferred for ZAPEX and ARPEX coupling series	m6	H7
		n6	H7
		h6	M7
		h6	P7
		k6	M7
		m6	K7
		n6	J7
		p6	H7
Shrink fit connection without parallel key	Only for steel hubs The permitted hub tension must be urgently checked.	s6	F7
		u6	H6
		v6	H6
		x6	H6

Deviation table to DIN ISO 286 for above-mentioned fits for bore diameters from 10 mm to 250 mm

Bore diameter above	up to	Deviations in µm Bore						Shaft					
		F7	H7	J7	K7	M7	P7	h6	j6	k6	m6	n6	p6
10	18	+34	+18	+10	+6	0	-11	0	+8	+12	+18	+23	+29
		+16	0	-8	-12	-18	-29	-11	-3	+1	+7	+12	+18
18	30	+41	+21	+12	+6	0	-14	0	+9	+15	+21	+28	+35
		+20	0	-9	-15	-21	-35	-13	-4	+2	+8	+15	+22
30	50	+50	+25	+14	+7	0	-17	0	+11	+18	+25	+33	+42
		+25	0	-11	-18	-25	-42	-16	-5	+2	+9	+17	+26
50	80	+60	+30	+18	+9	0	-21	0	+12	+21	+30	+39	+51
		+30	0	-12	-21	-30	-51	-19	-7	+2	+11	+20	+32
80	120	+71	+35	+22	+10	0	-24	0	+13	+25	+35	+45	+59
		+36	0	-13	-25	-35	-59	-22	-9	+3	+13	+23	+37
120	180	+83	+40	+26	+12	0	-28	0	+14	+28	+40	+52	+68
		+43	0	-14	-28	-40	-68	-25	-11	+3	+15	+27	+43
180	250	+96	+46	+30	+13	0	-33	0	+16	+33	+46	+60	+79
		+50	0	-16	-33	-46	-79	-29	-13	+4	+17	+31	+50

A

Cylindrical shaft ends, extract from DIN 748 Part 1 (long)

	Diameter in mm																					
	24	25	28	30	32	35	38	40	42	45	48	50	55	60	65	70	75	80	85	90	95	100
ISO tolerance zone	k6												m6									
End length in mm	50	60	80	110							140					170			210			

Central holes according to DIN 332 Part 2

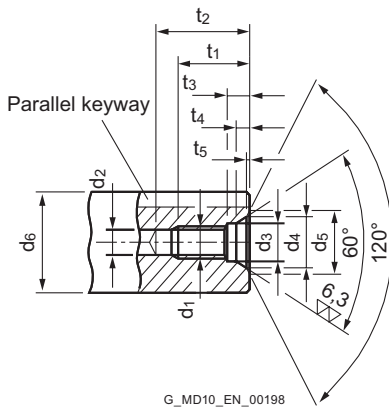

Form DS (with thread) DIN 332/2

Recommended diameter ranges d_6 ¹⁾		DS form dimensions									
above	up to	d_1	d_2 ²⁾	d_3	d_4	d_5	t_1 ₊₂	t_2 _{min.}	t_3 ₊₁	t_4 _{approx.}	t_5 _{approx.}
7	10	M3	2.5	3.2	5.3	5.8	9	12	2.6	1.8	0.2
10	13	M4	3.3	4.3	6.7	7.4	10	14	3.2	2.1	0.3
13	16	M5	4.2	5.3	8.1	8.8	12.5	17	4	2.4	0.3
16	21	M6	5	6.4	9.6	10.5	16	21	5	2.8	0.4
21	24	M8	6.8	8.4	12.2	13.2	19	25	6	3.3	0.4
24	30	M10	8.5	10.5	14.9	16.3	22	30	7.5	3.8	0.6
30	38	M12	10.2	13	18.1	19.8	28	37	9.5	4.4	0.7
38	50	M16	14	17	23	25.3	36	45	12	5.2	1.0
50	85	M20	17.5	21	28.4	31.3	42	53	15	6.4	1.3
85	130	M24	21	25	34.2	38	50	63	18	8	1.6
130	225	M30 ³⁾	26.5	31	40.2	44.6	60	77	22	8	1.9
225	320	M36 ³⁾	32	37	49.7	55	74	93	22	11	2.3
320	500	M42 ³⁾	37.5	43	60.3	66.6	84	105	26	15	2.7

¹⁾ Diameter refers to the finished workpiece

²⁾ Tap hole drill diameter according to DIN 336 Part 1

³⁾ Dimensions not acc. to DIN 332 Part 2

PARALLEL KEY CONNECTIONS TO DIN 6885-1

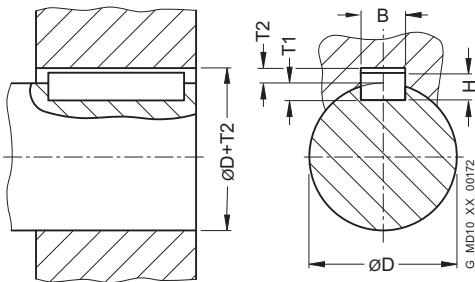

For moderate operating conditions, the hub keyway tolerance JS9 is recommended.

In harsh operating conditions or during reversing operation, the keyway width tolerance P9 must be preferred.

With two parallel keyways, the keyway width tolerance JS9 should be specified in order to simplify the assembly.

The shaft keyway width has to be specified with the tolerance N9.

Diameter above D mm	up to mm	Keyway width B mm	Parallel key height H mm	Shaft keyway depth T1 mm	Hub keyway depth T2 mm	Deviation for shaft and hub keyway depth mm	Deviation table for keyway width B	
							JS9 µm	P9 µm
	10	3	3	1.8	1.4	+0.1	+12.5 -12.5	-6 -31
10	12	4	4	2.5	1.8	+0.1	+15 -15	-12 -42
12	17	5	5	3	2.3	+0.1	+15 -15	-12 -42
17	22	6	6	3.5	2.8	+0.1	+15 -15	-12 -42
22	30	8	7	4	3.3	+0.2	+18 -18	-15 -51
30	38	10	8	5	3.3	+0.2	+18 -18	-15 -51
38	44	12	8	5	3.3	+0.2	+21.5 -21.5	-18 -61
44	50	14	9	5.5	3.8	+0.2	+21.5 -21.5	-18 -61
50	58	16	10	6	4.3	+0.2	+21.5 -21.5	-18 -61
58	65	18	11	7	4.4	+0.2	+21.5 -21.5	-18 -61
65	75	20	12	7.5	4.9	+0.2	+26 -26	-22 -74
75	85	22	14	9	5.4	+0.2	+26 -26	-22 -74
85	95	25	14	9	5.4	+0.2	+26 -26	-22 -74

Diameter		Keyway width B mm	Parallel key height H mm	Shaft keyway depth		Hub keyway depth T2 mm	Deviation for shaft and hub keyway depth mm	Deviation table for keyway width B	
above D mm	up to mm			T1 mm	T2 mm			JS9 µm	P9 µm
95	110	28	16	10	6.4	+0.2	+26 -26	-22 -74	
110	130	32	18	11	7.4	+0.2	+31 -31	-26 -88	
130	150	36	20	12	8.4	+0.3	+31 -31	-26 -88	
150	170	40	22	13	9.4	+0.3	+31 -31	-26 -88	
170	200	45	25	15	10.4	+0.3	+31 -31	-26 -88	
200	230	50	28	17	11.4	+0.3	+31 -31	-26 -88	
230	260	56	32	20	12.4	+0.3	+37 -37	-32 -106	
260	290	63	32	20	12.4	+0.3	+37 -37	-32 -106	
290	330	70	36	22	14.4	+0.3	+37 -37	-32 -106	
330	380	80	40	25	15.4	+0.3	+37 -37	-32 -106	
380	440	90	45	28	17.4	+0.3	+43.5 -43.5	-37 -124	
440	500	100	50	31	19.4	+0.3	+43.5 -43.5	-37 -124	



RELATED CATALOGS

Torsionally Rigid Couplings

FLE 10.1
FLEX-C10001-00-7600



Flexible Couplings

FLE 10.2
FLEX-C10002-00-7600



Highly Flexible Couplings

FLE 10.3
FLEX-C10003-00-7600



Fluid Couplings

FLE 10.4
FLEX-C10004-00-7600



ARPEX

High Performance Couplings
FLE 10.5
FLEX-C10120-00-7600



SIPEX und BIPEX-S

Backlash-free couplings
FLE 10.6
FLEX-C10121-00-7600



ARPEX

Safety couplings
FLE 10.7
FLEX-C10122-00-7600



FASTEX

Clamping elements
FLE 10.8
FLEX-C10152-00-7600



FLENDER SIP

Standard Industrial Planetary Gear Units

MD 31.1

PDMD-C10154-00

**FLENDER CHG**

Helical Gear Units

MD 20.10

PDMD-C10155-00

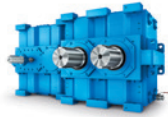
**Gear units**

Fast Track

MD 20.12

PDMD-C10156-00

**Bucket Elevator Drives**

MD 20.2

PDMD-C10157-00

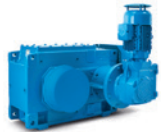
**PLANUREX 3**

Planetary Gear Units

FLE 20.3

FLEX-C10052-00-7600

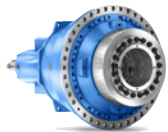
**Paper Machine Drives**

MD 20.5

PDMD-C10159-00

**Conveyor Belt Drives**

MD 20.6

PDMD-C10160-00

**Marine Reduction Gearboxes**

MD 20.7

PDMD-C10161-00

**DUORED 2**

Helical Gear Units, Load-sharing

MD 20.8

PDMD-C10162-00

**Pinion Drive for Tube Mills**

MD 20.9

PDMD-C10163-00





THE RIGHT GEAR UNIT SOLUTION FOR ANY REQUIREMENT

We provide helical and planetary gear units made up of standard modules or as a complete application solution.

Helical and planetary gear units from Flender are modern drive solutions that satisfy the most varying and extreme demands, day after day and year after year. For decades, plant operators have been achieving high system reliability and low lifecycle costs in every conceivable industry with our helical gear units.

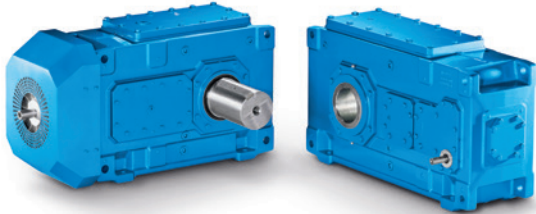

Helical and bevel helical gear units

Flender helical and bevel helical gear units are by far the most comprehensive range of industrial gear units in the world. It ranges from a multi-faceted universal gear unit portfolio and application-specific gear units to customer-specific solutions.

Rated torque: 3,300 Nm ... 1,400,000 Nm

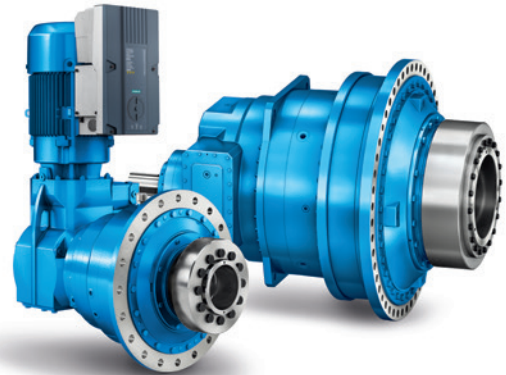

Planetary Gear Units

With Flender planetary gear units, we provide a range of durable, reliable and finely graduated gear unit solutions. The series wins customers over due to its highly integrated planetary geared motor and maximum conformity with all international motor standards. It also brings quality and performance in a good ratio of lifecycle costs to price.

Rated torque: 10,000 Nm ... 5,450,000 Nm

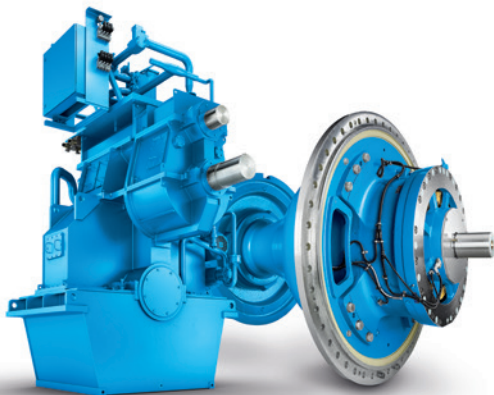

Application-specific gear units

With application-specific gear units, Flender provides by far the most application solutions and thus covers nearly every drive-related need from hundreds of applications in industry and the acquisition of raw materials.

Rated torque: up to 10,000,000 Nm



Customer-specific designs

Our experts are available at any time for special requirements during the development of new products. From designing and simulating complex drive solutions to implementing them, we work together with you to resolve multi-layered tasks.

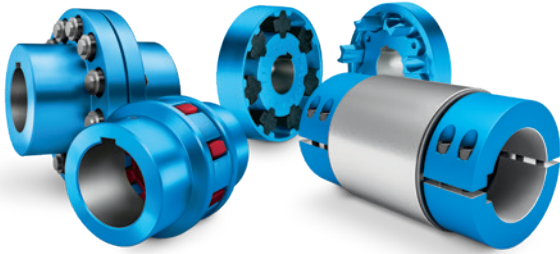

Flexible couplings

Our elastic couplings are pluggable and easy to install. The elastomer element equalizes the shaft offset and absorbs impacts from the motor or driven machine.

Nominal output torque: 12 Nm ... 1,690,000 Nm



Torsionally rigid couplings

Our compact steel couplings provide extremely precise transmission of high torques, especially in harsh operating conditions and extreme temperatures.

Nominal output torque: 92 Nm ... 7,200,000 Nm



Hydrodynamic couplings

Soft start, overload protection, torsional vibration damping – FLUDEX® fluid couplings allow the torque-limited approach and have very little slippage at rated load.

Power: 1.2 kW ... 2,500 kW



Highly-flexible couplings

Highly flexible couplings are well-suited for connecting machines that operate asymmetrically. They are preferred for use in systems that are periodically operated.

Nominal output torque: 24 Nm ... 90,000 Nm

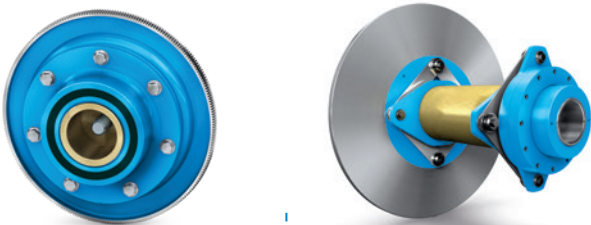

Application-specific couplings

Flender offers a variety of application-specific couplings for rail vehicles and use in wind energy generation.

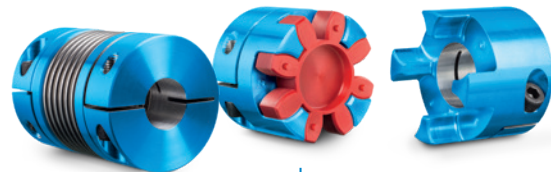

Backlash-free couplings

Our couplings act as a modular interface between the motor and the work machine to ensure reliable, backlash-free power transmission in servodrives and positioning drives.

Nominal output torque: 0.1 Nm ... 5,000 Nm

Flender's system competence turns first-class components into systems with tangible added value. Drive systems from Flender ensure maximum productivity, energy efficiency and reliability in any automation environment.

Consultation

Our customers use our interdisciplinary know-how, our application competence, our innovation strength and, last but not least, our experience to find the right drive system for their individual requirements.

Reduced engineering time, lower costs



Integrated drive portfolio

We not only provide gear units and couplings, but also have the competence in electrical drive technology that enables us to offer the entire drive train – perfectly integrated, with optimal interaction between all components, as a standard or individual solution.

Fewer interface risks, more efficiency

INDIVIDUAL SOLUTIONS.

We have the right solution for you, even if your requirements are special. We no longer have to newly develop every special solution. Many solutions are already available.

At [flender.com](https://www.flender.com), we provide application-specific solutions for your special requirements.

Use our online configurator, which allows you to create tailored product combinations.

Flender service

From diagnostics and support, replacement part and repair services, all the way to maintenance and retrofit services – the Flender service portfolio creates individual solutions, fully and completely tailored to the needs of our customers. In this way, a gear unit remains an original Flender gear unit.

Increased system availability, reduced lifecycle costs

DIAGNOSTEX

Ensuring the process stability requires status-oriented maintenance of the drive train. With DIAGNOSTEX®, sensors measure deviations of our gear units from the target status. These can be analyzed and evaluated in terms of maximized system availability.

Industrie 4.0, reduced costs

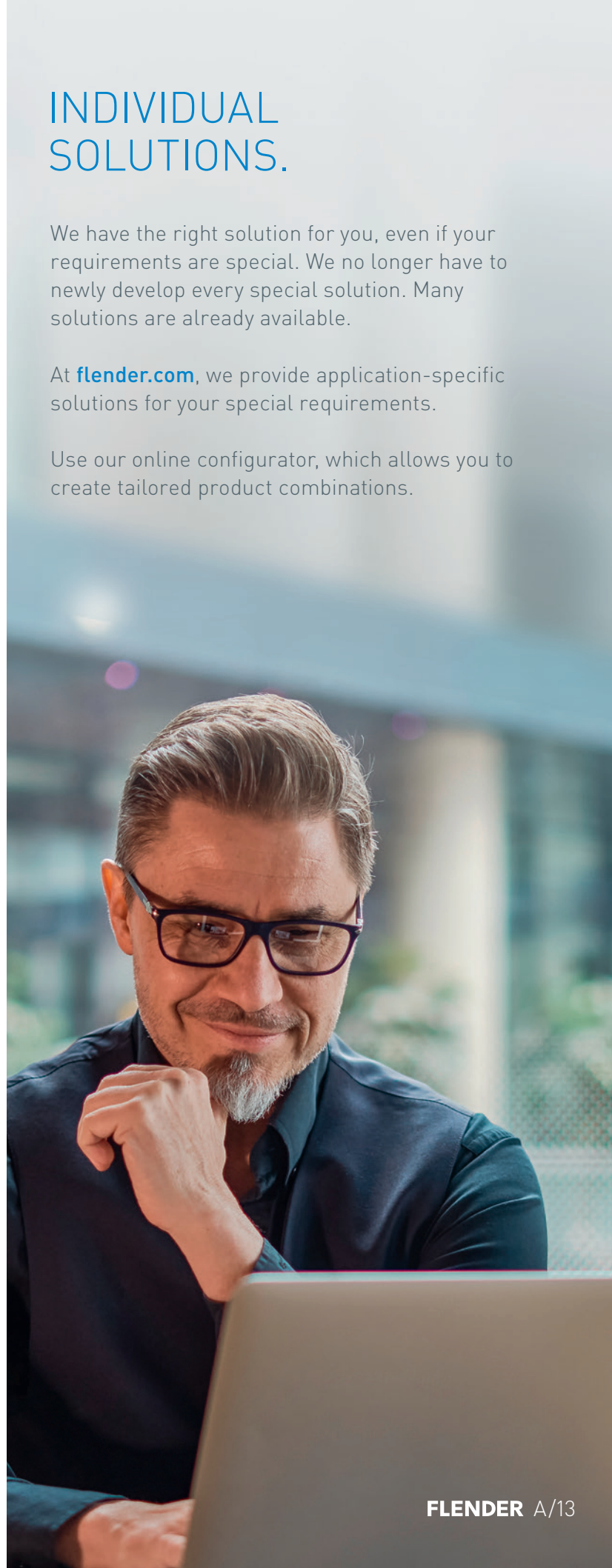

GREAT EXPERTISE IN YOUR INDUSTRY TOO.

Each industry has its own conditions. Every application has its own specific requirements. We are looking forward to meeting your challenges.

We probably already have the right solution at hand. Here are a few examples:



Minerals and mining

Requirement:
Perfectly coordinated drive system



Cement

Requirement:
Low maintenance effort and cost,
sealing due to dirt in surroundings



Plastics and rubber

Requirement:
Absorption of high axial forces,
suitability for explosion protection



Environmental and recycling

Requirement:
Highest possible reliability, rugged
design



Pulp and paper

Requirement:
Suitability for centrally located
lubrication



Industrial cranes

Requirement:
Quick availability, version with
double drive shaft



Chemicals

Requirement:
Absorption of forces from the manufacturing process



Power generation

Requirement:
Effective cooling, speed adjustment for motor to fan

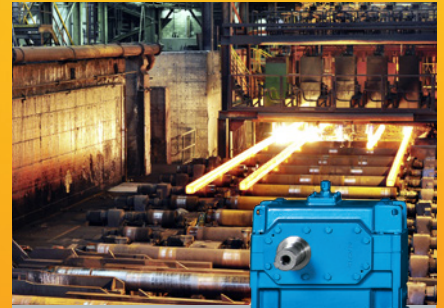

Metals

Requirement:
Harsh working conditions, high peak loads



Harbor cranes

Requirement:
Specific axle clearance, frequent start-up



Oil and gas

Requirement:
Flexible adaptation to speed requirements



Water and wastewater

Requirement:
Absorption of external forces, oil-retaining pipe required



AN ORIGINAL FOR THE LONG TERM WITH ORIGINAL FLENDER SERVICES

Ever increasing requirements make it more and more important for industrial plants to work with maximum productivity and efficiency. Flender Services give companies a decisive advantage over the competition in industry, the acquisition of raw materials and energy production. In view of the high cost pressure, increasing energy prices and stricter and stricter environmental stipulations, our services are becoming a decisive factor to success over the competition.

Enjoy the support of our service experts, from planning, development and operation to the modernization of your plant and benefit from our experience and in-depth know-how of your application – in more than 100 countries, seven days a week, 24 hours a day.

Reduce standstills, minimize downtimes due to failure, and increase the productivity, flexibility and cost efficiency of your plant.

OUR OFFER FOR GEAR UNITS AND COUPLINGS AT A GLANCE.

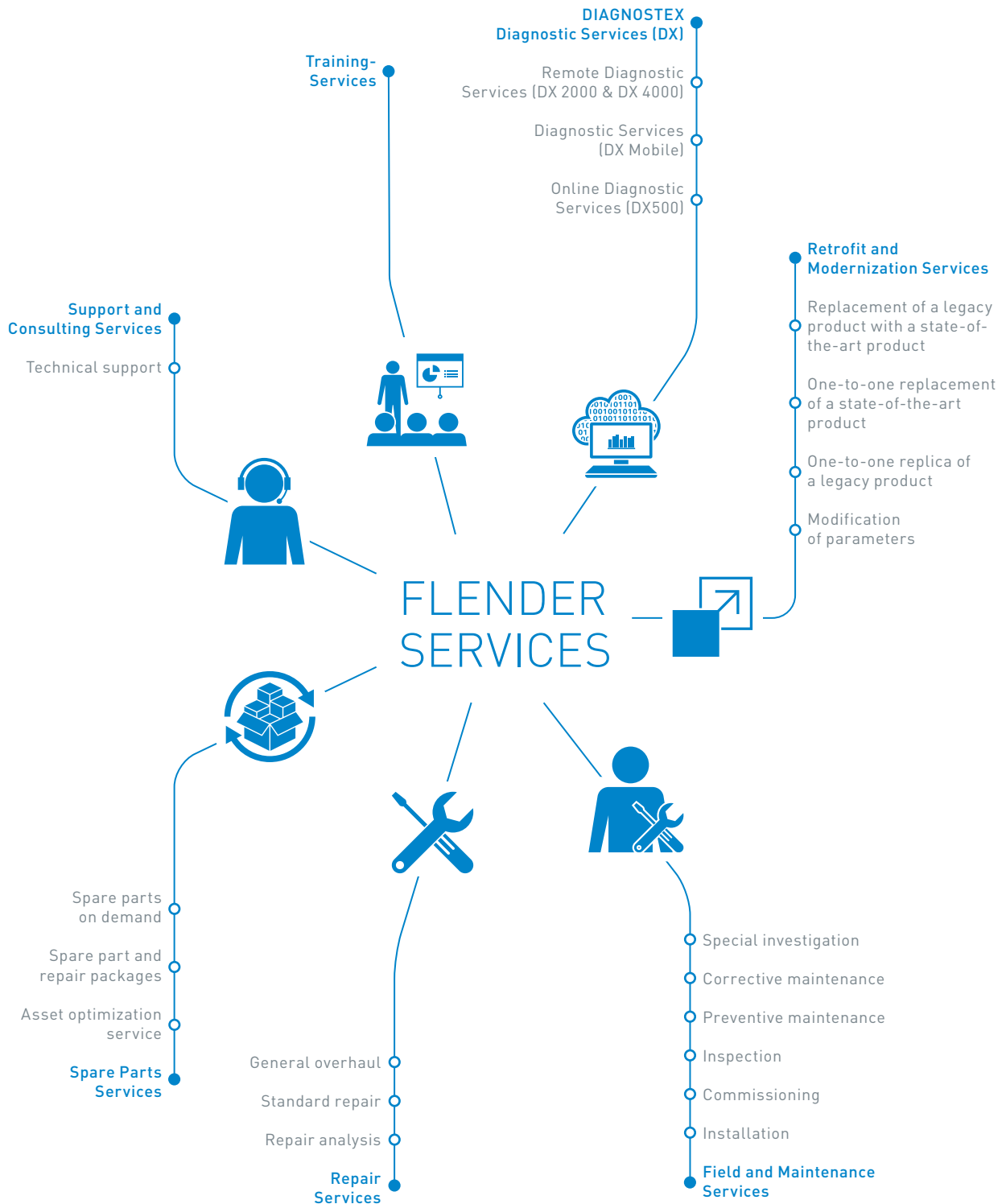

FLENDER COUPLINGS CATALOG **FLE 10.3** EDITION 2023 EN



WE
MOVE^{the}
WORLD

Flender GmbH

Alfred-Flender-Straße 77
46395 Bocholt
Germany

Article no.: FLEX-C10003-00-7600

Subject to changes and errors.

The information given in this product catalog includes descriptions and performance features that in specific applications do not always apply in the form described or may change through further-development of the products. The desired performance features are binding only if they are expressly agreed on conclusion of contract. Subject to availability for delivery and to technical changes.